



GOLF COURSE & DRIVING RANGE EQUIPMENT

2019 - 2020





MAKING THE DIFFERENCE

Over the past years we have become ever more convinced of the need to achieve economies of scale in order to be able to continue to deliver the best possible customer experience.

Through our merger with Piguy Golf Challenge we have achieved what we feel is the right size, a B2B platform to rival any in the business and we have taken a big step into the Proshop business.

We have again drastically increased our stock levels whilst at the same time combining and optimising our product ranges so that we can continue to provide the best possible logistics services from our 6,000 sqm warehouse in The Netherlands and remain the #1 supplier in Europe.

You, as our loyal customers, have made it all possible and we are grateful for this; be assured we will continue to strive to be making the difference and be the ultimate one stop shop in our Industry!

We welcome the opportunity to be of service to you in the near future and, with pride, present you our 2019-2020 catalogue.

Enjoyable reading!

Duco van Oosterhout

A handwritten signature in black ink, appearing to read "D. van Oosterhout", with a long horizontal line underneath it.

Founder and CEO



- CONTENT -

ON THE RANGE

05 - 66

ON THE COURSE

67 - 174

GREENKEEPER EQUIPMENT

175 - 207

IRRIGATION ACCESSORIES

208 - 223

PRO SHOP

224 - 231

TERMS & CONDITIONS AND
PRODUCT INDEX

232 - 237

NOTES

238 - 240

ON THE COURSE

Caddy Books	68
Score Cards	69
Teak Maintenance	70
Signage	71 - 73
Tee Signs	74 - 75
Ball Washers	76 - 84
Ball Washers Ensembles	78 - 79
Club Washers & Parts	85 - 86
Tee Markers	87 - 89
Broken Tee Caddies	90 - 91
Competition Markers	92 - 93
Distance Markers	94 - 98
Traffic Control	99
Hazard Markers	100 - 101
Traffic Control	102 - 103
Divot Mix Containers	104 - 105
Litter Bins	106 - 111
Water Coolers	112
Tee Towels	113
Ball Rack & Rental Trolleys	114
Flags	115 - 121
Flagsticks	122 - 129
Wooden Flagsticks	130
Measuring Systems	131
Placement Markers	132
Placement Flags	133
Putting Cups & Accessories	134 - 141
Event cups & Sure putt	140
Footgolf	142 - 143
Practice Green Markers	144 - 147
Junior Flags	148 - 149
Benches	150 - 151
On The Tee Accessories	152
Clocks	153
Atomic Clock	154
Information Signs	155 - 159
Rakes	160 - 169
Bunker Stamps	169
Shoe Cleaners	170 - 173
Cleaning Systems	174

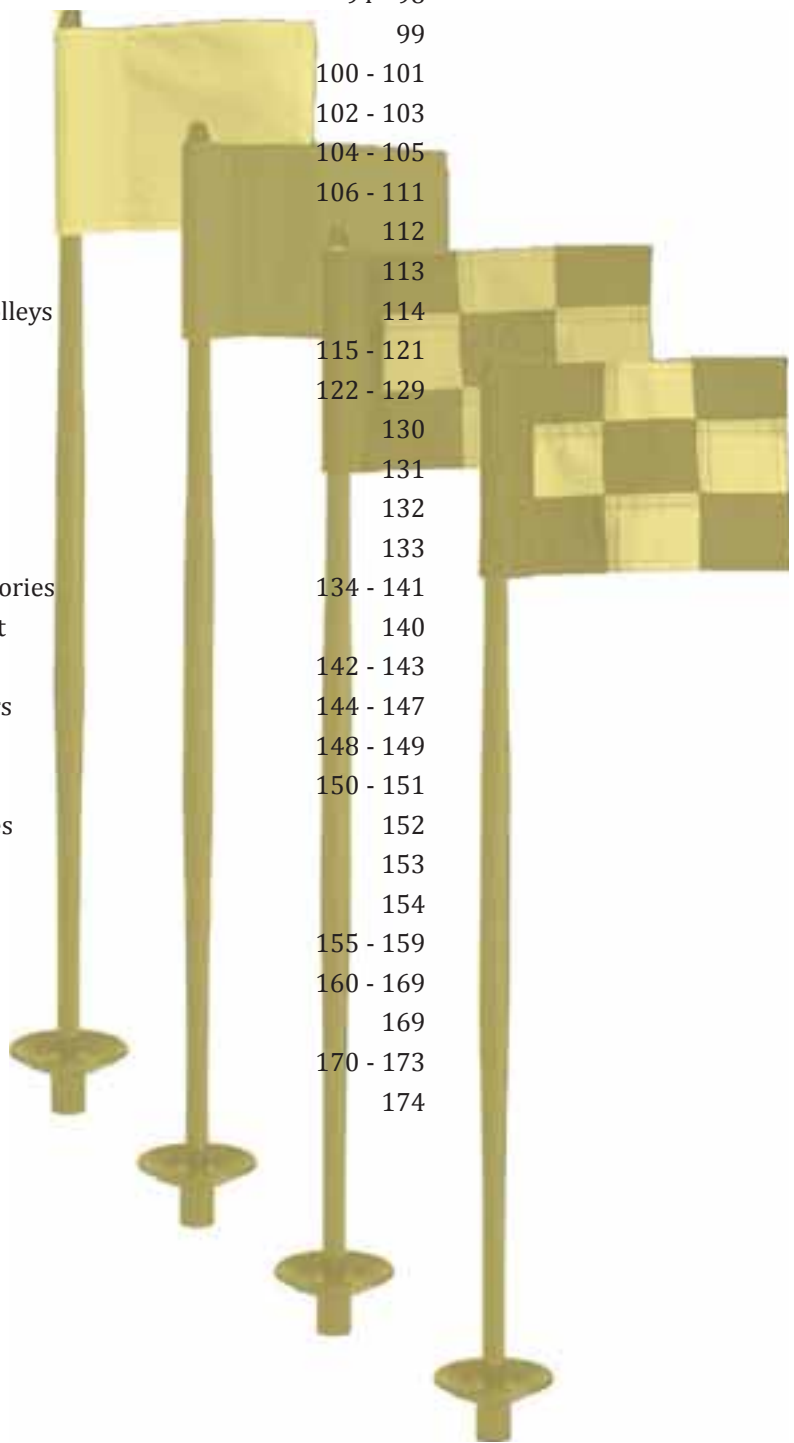

- CADDY BOOKS -



STANDARD GRAPHICS - STAPLED BOOKLET

- 1 page hole (up to 32 pages).
- 2D graphics.
- 165 mm x 95 mm.
- Full colour.
- Laminated covers.
- Stitched booklet on short or long edge.

CGSSSESTD

TOUR INSPIRED - STAPLED BOOKLET

- 2 page hole (up to 48 pages).
- 165 mm x 95 mm.
- Full colour.
- Laminated covers.
- Stitched booklet on short or long edge.

CGSSSETOUR

3D GRAPHICS - STAPLED BOOKLET

- 1 page hole (up to 32 pages).
- 165 mm x 95 mm.
- Full colour.
- Laminated covers.
- Stitched booklet on short or long edge.

CGSSSE3D

3D GRAPHICS - WIRO BINDED AND ROUND CORNERS BOOKLET

- 1 page hole (up to 32 pages).
- 165 mm x 95 mm.
- Full colour.
- Laminated covers.
- Stitched booklet on short or long edge.

CGWIRO3D

ADDITIONAL OPTIONS (PRICE PER BOOKLET)

Wiro Binding	CGWIROSTAP
Embossing	CGEMBOSS
Spot UV	CGSPOTUV
Foil	CGFOIL

Price per booklet include design, set-up, proofing and surveying (tee to green).

All prices are subject to final confirmation once all requirements are known.

- SCORE CARDS -

STANDARD 4 PAGE - SINGLE FOLD - SCORE CARD

- Standard size score cards.
- 134 mm x 80 mm per panel.

SC4PP

OVERSIZED 4 PAGE - SINGLE FOLD - SCORE CARD

- Oversized size score cards.
- 145 mm x 100 mm per panel.
- Price for 2,000 pcs.

SC4PPOS

STANDARD 6 PAGE - DOUBLE FOLD - SCORE CARD

- Standard size score cards.
- 134 mm x 80 mm per panel.
- Price for 2,000 pcs.

SC6PP

OVERSIZED 6 PAGE - DOUBLE FOLD - SCORE CARD

- Oversized size score cards.
- 145 mm x 100 mm per panel.
- Minimum order quantity: 5,000 pcs.

SC6PPOS

ADDITIONAL OPTION (COSTS PER ORDER)

- Round corners 4 page score card **SC4PPRC**
- Round corners 6 page score card **SC6PPRC**

LANDSCAPE FOLD- SCORE CARD

- Landscape fold score cards.
- 160 mm x 95 mm per panel.
- With rounded corners as standard.

SCLSRC



Prices include design, set-up, proofing and surveying (tee to green).
All prices are subject to final confirmation once all requirements are known.

- MAINTENANCE -

TEAK MAINTENANCE

Teak wood, like any other wood, is a natural material and will react to the effects of the natural changes of the weather and the exposure to direct sunlight. Please find below a brief description of the natural colour and surface change of any teakwood product.

If untreated, teak wood will turn 'grey'. Also a natural product will 'work' and the grains of the wood will open slightly due to the effects of the weather. Most people find the natural grey colour the 'charm' of the product. A yearly treat with (very fine) sandpaper can be done to keep the surface smooth.

Teak wood can be treated to keep the colour more like the light, more brown, colour. It then needs to be oiled with Teakoil and should be treated every 3-4 months for maximum preservation of the wood or could even be laquered in any colour you may wish. Do not hesitate to contact us should you need more information regarding preservation of teak wood.

TECHNOWOOD MAINTENANCE

Technowood is a 'zero maintenance' product – it may need cleaning every once in a while; for this use a damp soft cloth – do not use soaps or anything else, just wipe it down and let it dry. It is as simple as that.

Technowood has a colour guarantee of 10 years and a life expectancy of 30 years!

HARDWOOD / IROKO MAINTENANCE

Unfinished product

All timber products will retain a certain amount of moisture content, therefore some crazing or minor surface checking may occur soon after installation.

This movement is totally natural and beyond our control. Any movement that may occur is usually confined to the first year and in no way affects the suitability of the wood. Maintenance of untreated hardwood is the same as for Teakwood – see above.

Finished product: Finishing Process

The timbers are initially treated with Teknos Aquatop 2900 base coat stain. Once dry, the end grains are sealed to ensure maximum protection against moisture ingress. Finally, two topcoats of Teknos Aquatop 2600 are applied to achieve the maximum level of protection and colour.

After Installation

It is essential that all timber products be wiped down after any application of fertilisers or chemicals onto the course. Nitrogen based fertilisers, in particular, can burn through the protective coating in a matter of hours.

Maintenance Guidelines

The initial coating from our factory should last a minimum 12 months, however this is dependent on the location of the sign, specifically relating exposure to moisture, fluctuations in temperature, prevailing winds and excessive weather. - the only other maintenance required during this period is to keep the sign clean.

Ideally monthly, but at least once per year, all coatings should be washed with mild detergent and water to remove any surface marks, whilst being assessed for any damage or degradation that may require treatment.

In all cases, timber products should be checked periodically for 'damage', wear and tear. If the surface coating displays any damage, this will accelerate moisture ingress through the surface and subsequently cause possible degradation of the affected area.

If touching up or full repainting is required, a coating of Teknos Aquatop 2600 is preferred however a good quality proprietary external grade paint finish is acceptable. (Available from your local DIY store). If applied annually, the frames will continue to look good and perform as required.

Limitations

Local ground & climate conditions can vary greatly and must be considered by the installer for the effects on timber products. This information sheet is for general guidance only and all installations are the direct responsibility of the club or installer. No responsibility or liability can be accepted.



- SIGNAGE -



FINGER POST - TECHNOWOOD

- Made of UV resistant, maintenance free Technowood.
- Full 10 year colour retention guarantee.
- Available in 2 sizes: 120 cm & 180 cm.

Technowood finger post 120cm Brown	P78410
Technowood finger post 180cm Brown	P78411
Technowood finger post 120cm Green	P78412
Technowood finger post 180cm Green	P78413
Technowood finger post 120cm White	P78414
Technowood finger post 180cm White	P78415

FINGER POST - TECHNOWOOD ARROWS

- All Arrows including double sided signage.

Technowood finger post arrow Brown	P78421
Technowood finger post arrow Green	P78422
Technowood finger post arrow White	P78423

Optional Ground anchor **P78424**



FINGER POST - TEAK ARROWS

Finger post **DU82326**

- Post only.
- Size: 250 x 10 x 10 cm.

Finger teak straight **DU82327**

- Including double sided signage.

Finger teak 45° **DU82328**

- Including double sided signage.



FINGER POST - PLASTIC ARROWS

- Powder coated aluminium post.
- Multiple arrow possibilities at any angle.

Direction arrow hunter green **DU82500**

- Incl. text, maximum 15 letters.

Aluminium post 260 cm **DU82501**
Pipe cap **DU31002**



- SIGNAGE -

CAST MOW-OVER TEE PLAQUES

- Made by using a revolutionary technology that 'fuses' metal to high density urethane.
- Process uses less metal, less energy and eliminates virtually all toxic emissions into the air.
- Look, feel and perform like a foundry-poured sign but without the weight and the high production costs.
- Available in multiple sizes and shapes. Do ask for a custom quote.
- Custom logo at no extra cost.

Cast mow-over Ø 15 cm aluminium **DU34200**
 Cast mow-over Ø 15 cm bronze/ copper **DU34201**

Cast mow-over Ø 20 cm aluminium **DU34210**
 Cast mow-over Ø 20 cm bronze/ copper **DU34211**

Cast mow-over Ø 25 cm aluminium **DU34220**
 Cast mow-over Ø 25 cm bronze/ copper **DU34221**



ROUND MOW-OVER SIGN

- Provides a subtle and stylish marker.
- Available with superb natural granite or cast bronze plaques.
- Can also be used for creating an official fairway to green distance marker.
- Size: Ø 23,2 cm.

Mow-over black cast granite Ø 23,2 cm **PMOW1CG**

Mow-over granite Ø 23,2 cm **PMOW1NG**

Circular plinth Ø 32,5 cm with 23,5 cm recess **PMOWP**



PAR 3 DISTANCE SIGN

- Give golfers exact distance to the hole on par 3's with this sign.
- Place it in the cart path, near the bottom of a hill or right next to your tee markers.
- Size: 26 cm x 14 cm x 2 cm.

Sign Only **PA5380**
 Replacement back panel (2-pack) **PA5381**

Numbers sold in packs of 4:

"0" PA5380-0	"5" PA5380-5
"1" PA5380-1	"6" PA5380-6
"2" PA5380-2	"7" PA5380-7
"3" PA5380-3	"8" PA5380-8
"4" PA5380-4	"9" PA5380-9



- TEE SIGNS -



TECHNOWOOD TEE SIGNS

The new Technowood is a product similar to wood but does not present the limitations of the wood itself; it is made out of recycled PVC & Fiberglass and finished with a surface film giving a full 10 year warranty on colour retention and an estimated life of 30 years! No maintenance required at all and endless product possibilities.



The main advantages:

- Impact and pressure resistant.
- Resistant to water, humidity, heat and frost.
- UV resistant with a full 10 year colour retention guarantee.
- Absolutely maintenance free.
- Workability and fixing such as wood.
- Estimated lifetime of 30 years.
- Including sign.

TECHNOWOOD TEE SIGN TWEED

- | | |
|-------|---------------|
| Brown | P78510 |
| Green | P78511 |
| White | P78514 |

TECHNOWOOD TEE SIGN LEVEN

- | | |
|-------|---------------|
| Brown | P78512 |
| Green | P78513 |
| White | P78515 |

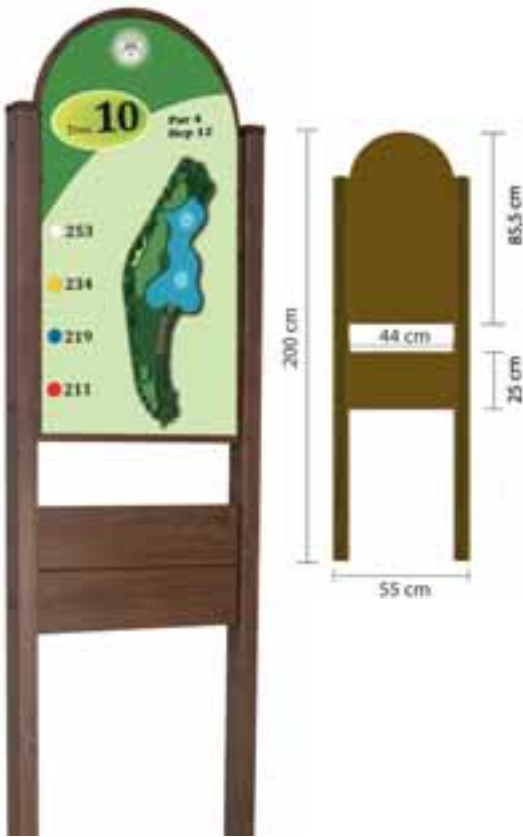

*Teesign Technowood
Tweed Brown*

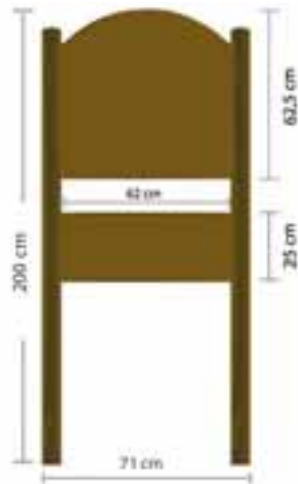

Teesign Technowood Leven Brown

- TEE SIGNS -



Tee signs can also be used for general information and routing purposes.

TEE SIGN PADDINGTON

- Made from teak wood.
- Including full colour hole layout.
- Excluding artwork.
- Size: 160 x 80 x 8 cm.

DU82347

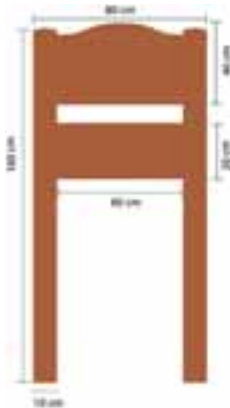

THE DUTCH TEE SIGN

- Made from teak wood.
- Including etched aluminium plates.
- Size: 55 x 12 x 12 cm.

DU82406



- BALL WASHERS -



THE PAR AIDE BALL WASHER

Far and away, Par Aide

No matter which Par Aide model you choose, your decision won't be challenged.

A Par Aide ball washer says golf. It says you care about quality. It tells golfers this superintendent is conscious of all the details that make a course enjoyable to play.

- Hand assembled from the highest-quality materials.
- Powder-coated cast aluminium body and cover, stainless steel hardware, nylon bristles set in rubber for durability.
- Patented helical agitator assures thorough cleaning and dependability.
- Improved integrity of powder coating because of a new pre-treatment process and the use of foam rubber gaskets between cover and body.



DELUXE BALL WASHER

Our most popular model. Drain plug located in front for easy cleaning and flushing. Patented internal overflow sends excess liquid down the inside of the pipe stand.

- Capacity: 3,3 litres.
- Weight: 4,5 kg.

- | | |
|-------------------------------|-----------------|
| Par Aide Red | PA203-01 |
| Hunter Green | PA203-02 |
| Black | PA203-00 |
| Other colours, please specify | PA203-99 |

Use with ball washer detergent.
See page 81.

Optional colours

Custom

Hunter Green	Par Aide Red	Par Aide Black	Par Aide Yellow	Par Aide White	Imperial Blue	Par Aide Blue	Industry Brown	Camel Beige	Any Colour

- BALL WASHERS -



MASTER BALL WASHER

The classic, original design.

- Capacity: 2,4 litres.
- Weight: 4,05 kg.

Par Aide Red	<i>PA205-01</i>
Hunter Green	<i>PA205-02</i>
Black	<i>PA205-00</i>
Other colours, please specify	<i>PA205-99</i>

PAR AIDE BALL WASHERS OFFER:

- One moving part; easy to maintain and replace.
Unit can be completely flushed and cleaned by removing only two coated, stainless steel set screws.
- Tamper-resistant drain plug with gasket eliminates any chance of leaking.
- Aluminium castings allow for unlimited colour options and unmatched durability.
- Known and preferred by golfers over the world.

RECOMMENDED MAINTENANCE:

- For effective cleaning, use Ball Washer Detergent.
- Regularly refill and change water.
- Touch-up paint as needed (see page 81).



- BALL WASHER ENSEMBLES -



These are a few of the ensembles created to make ordering easy for you. With all of these options, you can place your ensemble design where it's most needed. You may opt to put an ensemble with a club washer on the tee of a par 3 hole, for instance, or one with a Trash Mate® double unit on the tee following the halfway house. Just start with the combination you like and pick a colour. If you don't see the combination you are looking for, simply mix and match by choosing the individual items that best fit your situation.



MASTER ENSEMBLE

Par Aide Red **PA50-01**
 Hunter Green **PA50-02**
 Black **PA50-00**
 Other colours,
 please specify **PA50-99**



**MASTER ENSEMBLE WITH TRASH MATE®
 SINGLE UNIT**

Par Aide Red **PA51-01**
 Hunter Green **PA51-02**
 Black **PA51-00**
 Other colours,
 please specify **PA51-99**



**MASTER ENSEMBLE WITH TRASH MATE®
 DOUBLE UNIT**

Par Aide Red **PA52-01**
 Hunter Green **PA52-02**
 Black **PA52-00**
 Other colours,
 please specify **PA52-99**

Towels (not included on above models) may be purchased separately (see page 113).

- BALL WASHER ENSEMBLES -



Optional Colours

Custom



Par Aide
Red



Black



Yellow



White



Imperial
Blue



Par Aide
Blue



Industry
Brown



Camel
Beige



DELUXE ENSEMBLE

Par Aide Red **PA30-01**
 Hunter Green **PA30-02**
 Black **PA30-00**
 Other colours,
 please specify **PA30-99**

**DELUXE ENSEMBLE WITH TRASH MATE®
SINGLE UNIT**

Par Aide Red **PA31-01**
 Hunter Green **PA31-02**
 Black **PA31-00**
 Other colours,
 please specify **PA31-99**

**DELUXE ENSEMBLE WITH TRASH MATE®
DOUBLE UNIT, SPIKE BRUSH AND CLUB
WASHER**

Par Aide Red **PA34-01**
 Hunter Green **PA34-02**
 Black **PA34-00**
 Other colours,
 please specify **PA34-99**

Towels (not included on above models) may be purchased separately (see page 113).

- BALL WASHER PARTS & ACCESSORIES -



1. BALL WASHER BODIES

DELUXE BODY

- Weight: 2,7 kg.

Par Aide Red	PA1203-01
Hunter Green	PA1203-02
Other colours*	PA1203-99

MASTER BODY

- Weight: 1,8 kg.

Par Aide Red	PA1205-01
Hunter Green	PA1205-02
Other colours*	PA1205-99

2. BALL WASHER COVERS

DELUXE COVER

- Weight: 0,9 kg.

Par Aide Red	PA2203-01
Hunter Green	PA2203-02
Other colours*	PA2203-99

MASTER COVER

- Weight: 0,9 kg.

Par Aide Red	PA2205-01
Hunter Green	PA2205-02
Other colours*	PA2205-99

3. AGITATOR ASSEMBLY **PA200-30**

- Weight: 0,45 kg.
- Includes hex nut, grommet and top knob.

4. AGITATOR TOP KNOB **PA200-31**

5. CAP SCREW **PA200-21-4**

Set of 4

6. FOAM GASKET

Deluxe	PA203-25
Master	PA205-25

7. COVER LOCKING SCREW **PA203-70-6**

Set of 6

8. BRUSH ASSEMBLY **PA200-20**

- Weight: 0,9 kg.

9. TOWEL CLIP **PA200-60-4**

Set of 4

10. DRAIN PLUG WITH GASKET **PA203-40-4**

Set of 4

11. DRAIN PLUG GASKET **PA203-50-10**

Set of 10

12. AGITATOR LOCK NUT **PA200-80-4**

Set of 4

13. AGITATOR RUBBER GROMMET **PA200-11-4**

Set of 4

14. BASE LOCKING SCREW (not shown) **PA204-70-6**

Set of 6

15. DRAIN PLUG WRENCH (not shown) **PA203-10-4**

Set of 4

16. ALLEN WRENCH (not shown) **PA203-16-4**

for Locking Screw
Set of 4

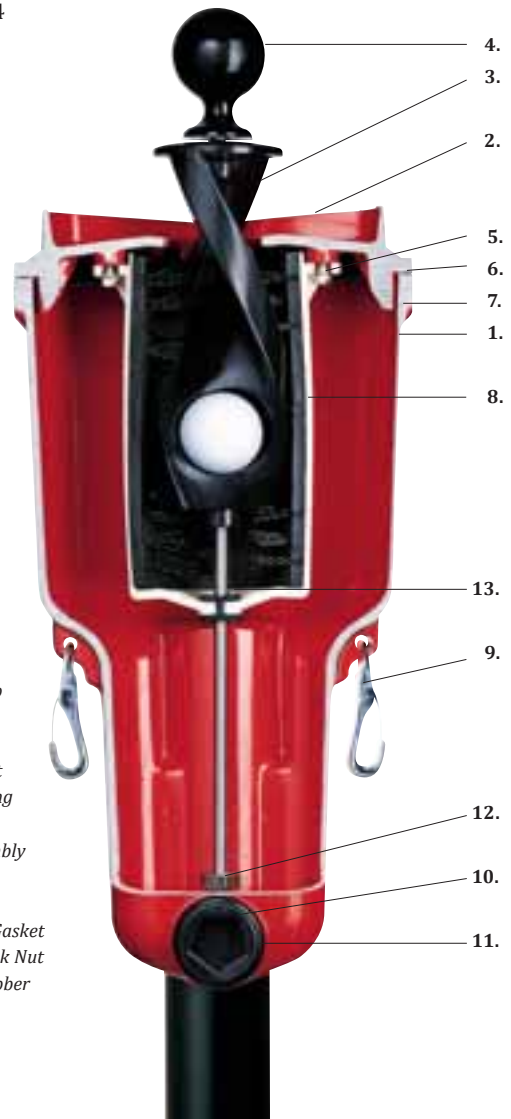

1. Body
2. Cover
3. Agitator assembly
4. Agitator Top Knob
5. Cap Screw
6. Foam gasket
7. Cover Locking Screw
8. Brush Assembly
9. Towel Clip
10. Drain Plug
11. Drain Plug Gasket
12. Agitator Lock Nut
13. Agitator Rubber Grommet

*Please specify colour

- BALL WASHER ACCESSORIES -



MOUNTING PIPE

- Lightweight, no-rust aluminium pipe for your ball washer installation.
- Powder-coated black finish.
- Size: Ø 6 cm.
- Use 87 cm with a Portable Base, 122 cm for in-ground installation.



Mounting Pipe 31 cm	PA209-00
Mounting Pipe 61 cm	PA212-00
Mounting Pipe 87 cm	PA210-00
Mounting Pipe 122 cm	PA211-00
Mounting Pipe Cap	DU31002

TOUCH-UP PAINT

- Matches the three Par Aide colours below.
- Adjustable fan spray can for expert results.

Gloss Black	PA1310-00
Par Aide Red	PA1310-01
Hunter Green	PA1310-02



BALL WASHER DETERGENT TABLETS

- Lemon-scented, non sudsing formula.
- Use one or 2 tablets with each clean and fill servicing.
- Large tablets provide a longer lasting cleaning solution.
- Eliminates the need for measuring proper amount.

Detergent tablets, jar of 2,27 kg	PA4102
Detergent tablets, case of 4 jars	PA4103



BALL WASHER LIQUID DETERGENT

- Lemon-scented, non sudsing concentrate formulated with antibacterial and odor-control agent.
- Less than 0,03 ltr. is all that is needed per clean and fill.
- Won't damage internal parts.

Liquid ball washer detergent, per 3,7 ltr	PA4110
Liquid ball washer detergent, case of 4	PA4112



BALL WASHER BRACKET

- Powder-coated black, aluminium bracket used to mount Master and Deluxe Ball Washers to any vertical flat surface 7,6 cm or wider.
- Weight: 0,45 kg

Ball washer bracket	PA215-00
---------------------	-----------------



- BALL WASHERS -

**STANDARD
GOLF** COMPANY



The PREMIER

Use with ball washer detergent.
See page 81.

TRADITIONAL SERIES BALL WASHERS

- Solid cast aluminium construction with powder-coated finish.
- Stainless steel hardware.
- Quickly clean single ball with spiral plunger action.
- The plunger is the only moving part, so maintenance is a snap.
- Plunger knob is easily replaceable if damaged.
- Give years of dependable, low-maintenance performance.

THE PREMIER

The larger of the aluminium Standard Golf ball washers, the Premier has an internal overflow and a large drain for easy maintenance. The Premier's cast aluminium construction will keep its bright colours and good looks for years to come.

- 3,3 litres washer fluid capacity.
- Mounts over post.

Red	SG01425
Green	SG01450
Black	SG01470



The MEDALIST

THE MEDALIST

The Medalist is economical, easy to use and maintain and it will be a favourite with your players too. It will last for years and still look great.

- 2,4 litres washer fluid capacity.
- Mounts inside post.

Red	SG01525
Green	SG01550
Black	SG01570

- BALL WASHERS -



CLASSIC BALL WASHER

- Wash up to four balls at once in our feature-packed, affordable priced Classic ball washer.
- Built rugged inside and out, it will look good and perform well for many years.
- Fast, no-splash crank operation.
- Overflow tube prevents leaks and soap built-up.
- Weight: 2,7 kg.



Yellow
SG01300



Red
SG01325



Green
SG01350



Blue
SG01375



INSTALLATION

- Order as part or a complete tee console with Tripod stand (SG36200) and Litter Caddie (see page 110).
- Attach to a mounting pipe for in-ground installation.

JUNIOR CONSOLE

The junior console is one of the most popular models and for good reason. Check out these features:

- Wide-stance tripod-style stand combines simplicity, utility, affordability; and it's built to last.
- Very portable. Easy to move around to minimize wear and tear in high-traffic areas.
- Screw-in spikes (included) anchor it firmly into the ground.
- Includes Junior Console Stand (Black) with a Classic Ball Washer and a colour matched 34 litre litter Caddie with spike.

JUNIOR CONSOLE WITH CLASSIC BALL WASHER

Red	SG39825
Green	SG39850
Black	SG39870



- BALL WASHER PARTS -

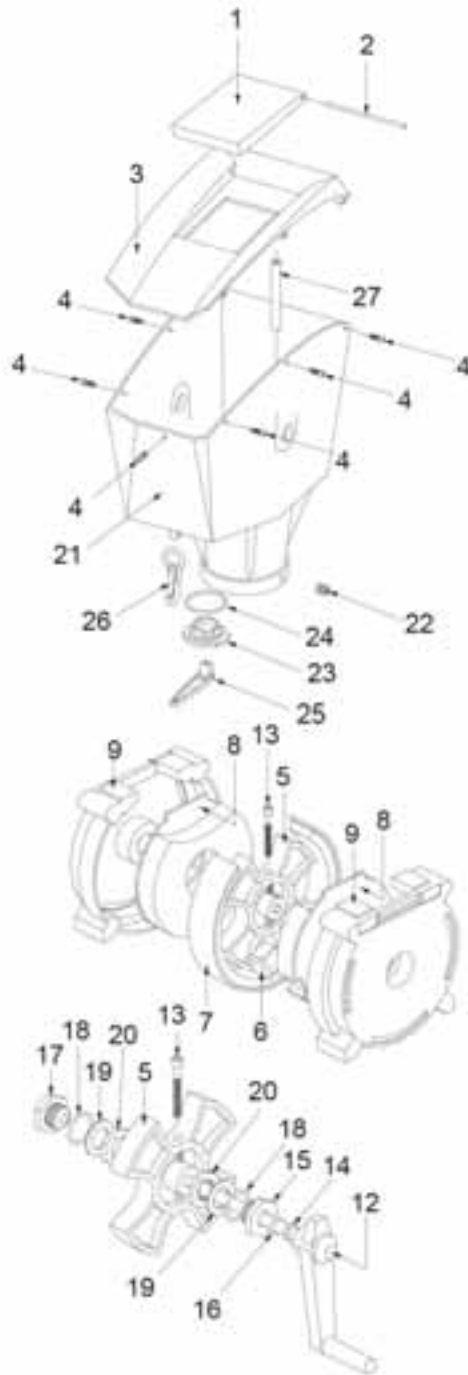

PARTS CLASSIC BALL WASHER

SG01300, SG01325, SG01340, SG01350, SG01370, SG01375, SG01395

- | | |
|---|----------------|
| 1. BALL WASHER LID | SG01303 |
| 2. HINGE PIN | SG01314 |
| 3. TOP | SG01302 |
| 4. 6 X 3/8" PHILLIPS PAN HEAD TRI-
PLASK SCREW | SG01313 |
| 5. IMPELLER | SG01342 |
| 6. RUBBER BUMPER | SG01323 |
| 7. RACE BRUSH | SG01348 |
| 8. SIDE BRUSH | SG01347 |
| 9. CARTRIDGE HALVES | SG01321 |
| 12. CRANK | SG01344 |
| 13. 10-24 X 1-1/2" STAINLESS STEEL
SOCKET HEAD CAP SCREW | SG01346 |
| 14. RETAINING PLUG | SG01311 |
| 15. OPEN END BEARING
<i>(is included with the SG01311)</i> | |
| 16. CRANK O-RING
<i>(is included with the SG01311)</i> | |
| 17. BLIND END BEARING | SG01318 |
| 18. BEARING O-RING | SG01331 |
| 19. FIBER GASKET | SG01332 |
| 20. PLASTIC LOCKNUT | SG01333 |
| 21. CASE
Case - Yellow | SG01301 |
| Case - Red | SG01326 |
| Case - Brown | SG01341 |
| Case - Green | SG01351 |
| Case - Black | SG01371 |
| Case - Blue | SG01376 |
| Case - White | SG01396 |
| 22. 5/16 X 1/2" STAINLESS STEEL SET
SCREW | SG01317 |
| 23. DRAIN PLUG | SG01328 |
| 24. DRAIN PLUG GASKET | SG01327 |
| 25. DRAIN PLUG WRENCH | SG01306 |
| 26. TOWEL SNAP | SG01320 |
| 27. OVERFLOW TUBE | SG01352 |

- CLUB WASHERS & PARTS -

TECHNOBROSS ULTRASONIC CLUB CLEANER

- Ultrasonic cleaning uses cavitation bubbles induced by high frequency (sound) waves to agitate a liquid.
- Is commonly used to clean jewelry and medical instruments.
- Gives an amazing result on on club heads & grips. Clean a batch of up to 12 clubs in only a few minutes.
- Gives a great service to the members.
- Can be equipped with a token or coin mechanism on request.
- Simple to operate, easy to empty.
- Compact and mobile unit.
- Size: Width: 82 cm, Depth: 76 cm, Height: 105 cm.



Technobross Ultrasonic Club Cleaner **DU49462**

ROUND CLUB WASHER

- Made of weatherproof recycled plastic with pointed slats for secure anchoring in turf.
- Interior bucket has attached brushed that clean club effectively.
- Size: Ø 36 cm, Height: 46 cm.

Black **MT692270**
 Brown **MT692271**
 Green **MT692272**

Club washer replacement brush, per pc **MT692270-1**



CLUB WASHER COMPLETE

- Capacity: 1,66 litre.
- Weight: 1,35 kg.

Red **PA250-01**
 Hunter Green **PA250-02**
 Black **PA250-00**

Replacement brushes, set of 2 **PA254**



RANGE MATE CLUB WASHER

- Gentle, no-splash brushes will handle woods and irons.
- Efficient, effective design with replaceable brushes.
- Large-capacity, fade-resistant 34 litre polyethylene containers, reinforced with steel frame.
- New square opening allows easier access to clean clubs.
- Available in Hunter Green.
- Comes with floorstand.

Range mate clubwasher, Hunter Green **SG01650**
 Replacement brush for Range Mate (p/pce) **SG01602**



- CLUB WASHER PARTS -



MOUNTING PIPE 30,5 CM

- For use with portable base.
- Weight: 0,45 kg.

PA209-00



OPTIONAL MOUNTING BRACKET

- Mounts a club washer to any 5,1 cm pipe or any flat surface 15,2 cm or wider.
- Hardware included.
- Weight: 0,45 kg.

PA275



SINGLE SPIKE MOUNTING KIT

- Bolts to bottom of club washer, and moves as easily as a tee marker.
- Hardware included.
- Weight: 0,45 kg.

PA260



BALL WASHER REPLACEMENT KIT

- Everything you need for refurbish.
- Foam gaskets for covers included but not shown.
- For the Par Aide Master and Deluxe ball washer models.
- Weight: 1,35 kg.

PA200-10

- TEE MARKERS -



PINE TEE MARKER

- Made from durable resin.
- Very natural look.
- Ends slanted for more visibility.
- With two steel spikes.
- Size: 20 x 10 cm.
- Weight: 1,3 kg.

White	DU34024
Yellow	DU34025
Red	DU34026
Blue	DU34027
Black	DU34028
Orange	DU34029



AUGUSTA TEE MARKER

- Teak tee marker.
- Blends in well with surroundings.
- Size: 25 cm.
- Comes with two zinc plated 16 cm spikes.
- Carton: 6 pieces.

Red	DU34001
White	DU34002
Blue	DU34003
Yellow	DU34004
Black	DU34005
Orange	DU34006



TEAK TEE MARKER SQUARE

- Made from teak wood.
- For a real classic look.
- With stainless steel spike.
- Size: 15 x 10 x 10 cm.
- Banded vinyl colour.

DU82329

Please state colour.



PATISSON DIMPLE TEE MARKER FLAT

- Made from durable solid resin.
- Nearly unbreakable.
- Stainless steel 10 cm spike.
- Weight: 0,38 kg.
- Diameter: 15 cm.

White	P407115W
Yellow	P407115Y
Red	P407115R
Blue	P407115B
Black	P407115BL
Orange	P407115O



- TEE MARKERS -



DIMPLE-T MARKERS

- The popular line of Dimple-T Markers is available in just about every colour you can imagine.
- Choose from two eye-catching styles: classically plain or personalised with your club logo and / or hole number.
- Made of space age polymers with molded-in galvanised steel spike.
- Size: Ø 13 cm.
- Weight: 0,35 kg.
- Carton: 18 pieces.

PLAIN DIMPLE-T MARKERS

Red **CA16361**
 White **CA16362**
 Blue **CA16363**
 Yellow **CA16364**
 Black **CA16365**

PERSONALISED DIMPLE-T MARKERS

CA16381
CA16382
CA16383
CA16384
CA16385

Silver **CA16366**
 Gold **CA16367**
 Orange **CA16368**
 Green **CA16360**
 Pink **CA16371**

CA16386
CA16387
CA16388
CA16380



PERSONALISE YOUR MARKERS

Colourful, personalised or numbered decals can be supplied, but they must be ordered separately.

Decal size: Ø 7 cm.

Sticker for personalised Dimple-T up to 18 pieces

Sticker for personalised Dimple-T 19-36 pieces

Sticker for personalised Dimple-T 37+ pieces

STICKERDP1

STICKERDP2

STICKERDP3

STICKER SETS OF NUMBERS FOR DIMPLE TEE MARKERS

- Set of 9 includes two of each number.

Set 1-9, *Please state colour* **CA31652**

Set 10-18, *Please state colour* **CA31651**



CAST TEE MARKERS

- Made by using a revolutionary technology that 'fuses' metal to high density urethane.
- Process uses less metal, less energy and eliminates virtually all toxic emissions into the air.
- Look, feel and perform like a foundry-poured sign but without the weight and the high production costs.
- Available in multiple sizes and shapes. Do ask for a custom quote.
- Custom logo at no extra cost.

Cast Tee Marker Ø 15 cm round aluminium

DU34300

Cast Tee Marker Ø 15 cm round bronze or copper

DU34301

- TEE MARKERS -



*With neck
without engraving.*



*With neck and
engraving.*



*Without neck, and
engraving.*

FORE-EVER MARKED TEE MARKER

- Made from a special blend of resins.
- Incredibly durable with a mirrored finish.
- Size Ø: 7,6 cm , 10,2 cm, 12,7 cm.
- Comes with or without neck.
- Fitted with stainless steel spike.
- One colour engraved custom logo available on request.
- Please ask us for a quote and delivery time for engraving.

WITH NECK	7,6 CM	10,2 CM	12,7 CM
Red	MT635301	MT635401	MT635501
White	MT635302	MT635402	MT635502
Blue	MT635303	MT635403	MT635503
Yellow	MT635304	MT635404	MT635504
Black	MT635305	MT635405	MT635505
Orange	MT635307	MT635407	MT635507
Custom colour	MT635310	MT635410	MT635510

WITHOUT NECK	7,6 CM	10,2 CM	12,7 CM
Red	MT635331	MT635431	MT635531
White	MT635332	MT635432	MT635532
Blue	MT635333	MT635433	MT635533
Yellow	MT635334	MT635434	MT635534
Black	MT635335	MT635435	MT635535
Orange	MT635337	MT635437	MT635537
Custom colour	MT635340	MT635440	MT635540



SPHERICAL PLASTIC TEE MARKER

- One of the most economical markers. Features welded, 2-piece construction with cast-in stainless steel spike attached.
- Size: Ø 10 cm.

White	PA640-2
Yellow	PA640-4
Red	PA640-1
Blue	PA640-3
Black	PA640-5



- BROKEN TEE CADDIES -



BELL BROKEN TEE CADDY ALUMINIUM

- Made of top grade cast aluminium with powder coated finish.
- Comes with stainless steel spike and broken tee decal.
- Size: 10 cm high and Ø 13 cm.
- Weight: 0,45 kg.

Black	DU18000
Yellow	DU18015
Red	DU18025
Green	DU18050
Blue	DU18075
White	DU18095
Orange	DU18096



BROKEN TEE BOX

- Sits directly on the ground. Legs allow for air flow.
- Fade- and rust-resistant and maintenance-free.
- Powder-coated expanded metal bottom.
- Size: 20 x 25 x 9 cm.

Hunter Green	PA3490
Black	PA3491
Redwood	PA3492
Caramel	PA3493



Colours: Hunter Green, Black, Redwood & Caramel



- BROKEN TEE CADDIES -



BROKEN TEE CADDY STEEL

- To get rid of the nuisance of broken tees.
- Keep your tee surface clean and organised.
- Made of powder-coated steel and separate spike.
- Cover with hole and text: TEES ONLY optional.
- Size: 15 cm high and Ø 13 cm.
- Weight: 0,34 kg.
- Packed per 3.

Black	CA20111
Yellow	CA20126
Red	CA20136
Green	CA20161
Blue	CA20186
White	CA20106



BROKEN TEE CADDY PLASTIC

- Keep your tee surface free from broken tees.
- Made of plastic with integrated thread for steel spike.
- Cover with hole and text: TEES ONLY optional.
- Size: 15 cm, Ø 13 cm.
- Weight: 0,4 kg.
- Carton: 9 pieces.

Black	PC19000
Yellow	PC19015
Red	PC19025
Green	PC19050
Blue	PC19075
White	PC19095
Orange	PC19096



BROKEN TEE CADDY COVER

- Cover with hole and text: TEES ONLY.
- For plastic and steel broken tee caddy.

PC19100



- COMPETITION MARKERS -

Place a contest indicator on the tee to announce the contest on that hole.
The proximity marker goes in the fairway or green to mark the longest drive, closest to the pin or other contest.

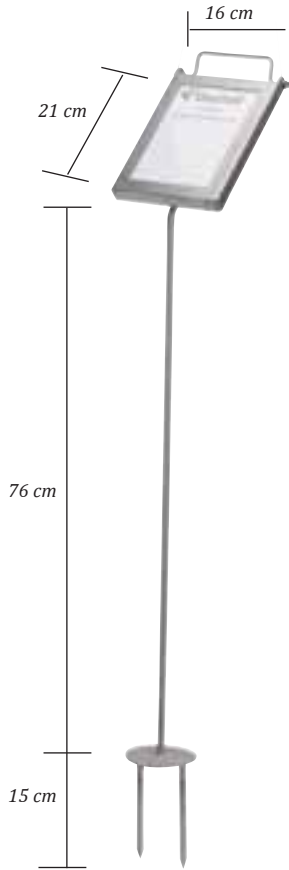

STAINLESS STEEL CONTEST INDICATOR, MESSAGE HOLDER OR LONGEST DRIVE INDICATOR

- A classy and durable solution for any message you would like to put on the tee.
- Made of stainless steel.
- Holds 20 x 15 cm cards (not included).

Stainless steel indicator holder **PC19210**



Hinged lid provides easy access to message card.



PROXIMITY MARKER AND CONTEST INDICATOR

- Paper-free proximity marker includes an attached grease pen, contest indicator, unattached grease pen.
- Choose stock design, or customize with course or event logo (price on request).
- Cleanup: Wipe with a clean towel, any household cleaner helps.
- Reusable, rainproof Polycarbonate surface eliminates paper sheets.

Contest indicator **PA10602**
Proximity marker **PA10600**

REPLACEMENT PARTS (NOT SHOWN)

Replacement pen with Velcro **PA10690**
Tube of 6 replacement leads **PA10691**



Contest indicator



Proximity marker

SUPER TIP: Spray surface with WD40 for easy cleaning.

- COMPETITION MARKERS -

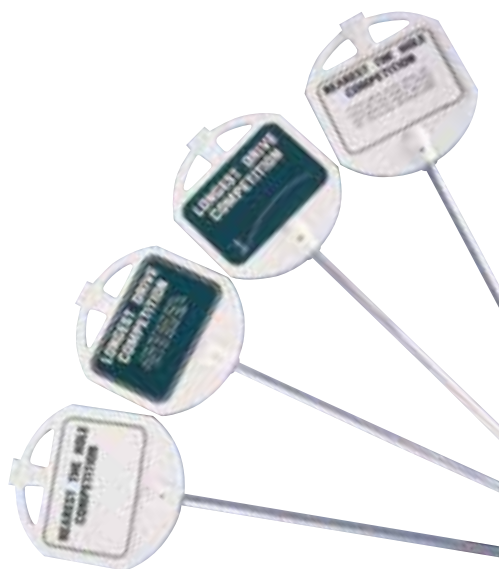

CAST ALU CONTEST INDICATOR AND PROXIMITY MARKER

- Made in cast aluminium for that traditional look.
- Each set comes complete with card holder and cards.

Indicator Nearest to the Hole	PCA602-01
Indicator Longest Drive	PCA602-02
Proximity Marker Nearest to the Hole	PCA602-03
<i>Card holder with cards on the back</i>	
Proximity Marker Longest Drive	PCA602-04
<i>Card holder with cards on the back</i>	

COMPLETE SET

PCA602-01, -02, -03, -04	PCA602
Replacement cards (50 pcs.)	PC19203



PLASTIC CONTEST INDICATOR AND PROXIMITY MARKER

- White plastic marker head.
- Aluminium spike.
- Proximity markers are including card holder and cards.



Plastic contest Indicator Nearest	PC19200
Plastic contest Indicator Longest Drive	PC19201
Plastic contest Proximity Marker Nearest	PC19204
<i>Card holder with cards on the back</i>	
Plastic contest Proximity Marker Longest Drive	PC19205
<i>Card holder with cards on the back</i>	
Replacement cards (50 pcs.)	PC19203

PROXIMITY MARKERS

- Easy-to-read.
- Four markers with pencil holders.
- Four packs of double-sided cards (25 each) printed with Long Drive on one side and Proximity on the other.
- Size: 66 cm tall, pad area is 20,3 cm x 12,7 cm..



Set of four markers	SG10700
Replacement cards (25 pcs.)	SG10701



- DISTANCE MARKERS -



TEAK DISTANCE POSTS

- Made from teak wood.
- Size: 100 x 5 x 5 cm.

Post 100	<i>DU82320</i>
Post 150	<i>DU82321</i>
Post 200	<i>DU82322</i>



PROPLEX DISTANCE MARKER

- Proplex distance post – great looking – great visibility – no maintenance!
- Recycled plastic distance post.
- Maintenance free.
- Complete with Aluminium ground socket.
- Total post dimensions: 75 x 5 x 5 cm.
- Goes around 20 cm into the ground.
- Colour black – on request available in other colours.

Post 100	<i>PFW-300-B100</i>
Post 150	<i>PFW-300-B150</i>
Post 200	<i>PFW-300-B200</i>



INDIVIDUAL PVC DISTANCE MARKERS (INCLUDING CAP AND DECAL)

- For a sharp, more visible look.
- 18 cm PVC ground anchors make the markers easy to remove and replace. (not included)
- Includes cap and decal.
- Height: 81 cm.
- Weight: 0,37 kg.

White with red 100 decal	<i>SG09310</i>
White with black 150 decal	<i>SG09320</i>
White with blue 200 decal	<i>SG09330</i>
White with yellow 250 decal	<i>SG09340</i>
Yellow with black 150 decal	<i>SG09350</i>

PVC ground anchor	<i>SG16157</i>
Driving tool	<i>SG16158</i>

- DISTANCE MARKERS -



RECYCLED RUBBER TEE DISTANCE MARKERS

These colourful, recycled rubber markers are perfect for marking the exact tee to green distance.

- Made from recycled tires.
- UV resistant.
- Colours coordinate with tee markers.
- Will not rust, chip or damage mowers and trimmers.
- With 14 cm steel spike.
- Weight: 1,4 kg.
- Height: 2,9 cm.
- Size Ø: 20 or 28 cm.
- Carton: 10 pieces.



	Ø 20 cm	Ø 28 cm
Red	CA10111	CA10161
White	CA10112	CA10162
Blue	CA10113	CA10163
Yellow	CA10114	CA10164
Black	CA10116	CA10166

STEEL DISTANCE MARKER

- Helps players to judge distances to the green.
- Brightly coloured powder coated marker.
- With 24 cm spike.
- Size Ø: 30 cm.
- Carton: 7 pieces.

Red	CA10311
White	CA10312
Blue	CA10313
Yellow	CA10314



TUMMY STEEL MARKER

- Helps players to judge distances to the green.
- Can be used as tee-, fairway- or hazardmarker.
- Size Ø: 15 cm.

Red	DU34080
White	DU34081
Blue	DU34082
Yellow	DU34083
Orange	DU34084
Purple	DU34085



- DISTANCE MARKERS -



ALUMINIUM DISTANCE MARKER

This beautiful shaped marker is available in aluminium in the colour green with an UV protecting lacquer.

- Aluminium powder coated marker.
- 1 stripe: 100 mtr, 2 stripes: 150 mtr, 3 stripes: 200 mtr.
- Height: 85 cm / Ø: 6 cm.
- Order ground anchor separately.

ALUMINIUM MARKER

Aluminium Marker* **DU49209**

Synthetic ground anchor **DU49216**

Driving tool **SG16158**

**Please specify the number of rings*



LAMINATED FAIRWAY DISTANCE MARKERS

- Dependable and economical yardage marker for your course.
- The Ø 28 cm marker features routed numbers.
- Reliable and weather-resistant.
- Includes stainless steel spike to secure the marker.

	Ø 15 cm		Ø 28 cm
Red	PA5330	Red 100	PA5300
White	PA5331	White 150	PA5301
Blue	PA5332	White 200	PA5303
Black	PA5333	Blue 200	PA5304
Yellow	PA5334	Blue 250	PA5305
		Black 250	PA5306
		Yellow 150	PA5307



THE KIRBY MARKER SYSTEM

- Complete line of fairway and tee distance markers.
- Because they are above the turf (but can be driven right over) they are visible from any direction.
- Choose the complete Kirby marker system that 1.000 courses throughout the world use to speed up play, build revenue and increase golfer satisfaction.

STANDARD KIRBY MARKERS

Red	DU34030
White	DU34031
Yellow	DU34032
Blue	DU34036

Please state distance.



- DISTANCE MARKERS -

SPEED AND QUALITY OF PLAY...GOLF AS IT SHOULD BE

You know Grund Guide for making premier yardage marking solutions. Now backed with the strength of Underhill@ distribution and product development, you can have the highest quality and most complete yardage marking systems available today and into the future.

DIFFERENT MODELS FOR DIFFERENT SPRINKLER HEADS

Perfect-fit caps engraved and colour filled for high visibility. Multiple number locations vary for lids with holes.



MODEL SPM 106 TORO

Fits: Toro 730, 750, 760, 780, 830/850S, 834S, 835S, DT34/35S. 854S. DT54/55, 860S, 880S.

- Colour caps: black, white, yellow, lavender.
- Colour numbers: white, black, yellow, red, blue, green, lavender.

SPM106-TORO

Please specify colour of caps and numbers



MODEL SPM 107 RAIN BIRD

Fits: Rain Bird E900, E950, E700, E750, E500, E550, 700, 751, 51DR.

- Colours caps: black, white, yellow, lavender.
- Colours numbers: white, black, yellow, orange, red, blue, green, lavender.

SPM107-RAIN BIRD

Please specify colour of caps and numbers



MODEL SPM 101 FIT OVER DISCS

Anodized aluminum (no paint!), these markers are engraved and custom fit to each sprinkler. Multiple number locations vary for lids with holes.

Fits: Toro 630, 650, 660, 670, 680, 690, 830/850S, 834S, 835S, DT34/35, 854S, 855S, DT54/55, 860S, 880S, Rain Bird 47/51 DR, 71/91/95, E900, E950, E700, E750, E500, E550, 1100, Hunter G-70/75, G-90/95, G-990, G-995, John Deere/Signature – Call.

- Colour tags: black, bordeaux, lavender.
- Colour numbers: grey.

SPM101-FITOVER

Please specify colour of tags and numbers



MODEL SPM 105 FIT MOST HEADS

Anodized aluminum (no paint!), these markers are engraved and custom fit to each sprinkler. Multiple number locations vary for lids with holes.

- Colour tags: black, bordeaux, lavender.
- Colour numbers: grey.

SPM105-

Please specify colour of tags and numbers



- One marking engraved on sprinkler cap **X-#1YM**
- Two markings engraved on sprinkler cap **X-#2YM**
- Three markings engraved on sprinkler cap **X-#3YM**

- DISTANCE MARKERS -

FAIRWAY - TEE - RANGE DISTANCE MARKERS

Large 17,78 cm (7 1/2") cap with big bold 7,62 cm (3 1/2") standard yardage numbers. Ideal for fairway, tee and driving range marking. Optional 20,32 cm (8") mounting pipe attachment available for secure installation.

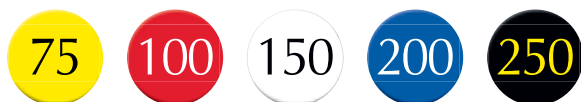

STANDARD FAIRWAY DISC SYSTEM

Colour-coded markers with bold 7,62 cm (3 1/2") yardage number.

Several system options available.



Yellow disk with 75
Red disk with 100
White disk with 150
Blue disk with 200
Black disk with 250

UFTM-Y-75
UFTM-R-100
UFTM-W-150
UFTM-BL-200
UFTM-BK-250

ORDER SEPERATELY:

Optional 20,32 cm (8") mounting pipe (installs easily with standard cup cutter) **UFTM-PL**

CUSTOM FAIRWAY DISC OPTIONS

Markers can be customized to display specific yardage numbers, include logos, or custom design.



Disk no markings

UFTM

Please state colour: Yellow, Orange, Red, White, Blue, Black, Green and Lavender.



Disk incl. one custom number

UFTM-#1

Disk incl. two custom numbers

UFTM-#2

Disk incl. three custom numbers

UFTM-#3

Logo added to disk

UFTM-LOGO

ORDER SEPERATELY:

Optional 20,32 cm (8") mounting pipe (installs easily with standard cup cutter) **UFTM-PL**

DIFFERENT MODELS FOR DIFFERENT SPRINKLER HEADS

Perfect-fit caps engraved and colour filled for high visibility. Multiple number locations vary for lids with holes.



MODEL SPM 103 TORO SNAP IN

OEM UPGRADE to high quality polycarbonate custom fit. One complete, high-visibility marker snaps into OEM plug.

Fits: Toro 730, 750, 760, 780, 830/850S, 834S, DT34/35, 854S, DT54/55, 860S, 880S

Colour snap in: white, yellow and lavender

Colour numbers: white and black

SPM-103

Please specify colour of Snap In and numbers

MODEL SPM 108 TORO & HUNTER

Special engraved plastic material designed to fit into OEM lid recess.

Fits: Toro 730, 750, 760, 780, 834S, DT34/35, 854S, DT54/55, 860S, 880S and Hunter G800, G70/75B, G870, G875, G880, G885, G990, G995

Colour markers: white and yellow

Colour numbers; black



SPM108 - TORO & HUNTER

Please specify colour of caps and numbers

- TRAFFIC CONTROL -



BARRIER HOOPS - STEEL PLASTIC COATED

- Zinc passivated prior to polyester powder-coating to ensure excellent paint adhesion, reducing flaking and increase life of product.
- Improved welding technique to further improve the quality.
- Can be pushed into the ground using foot close to the loop.
- Colour: white
- Size: (H) 30 cm x (W) 61 cm x (Ø) 8 mm.
- Carton: 10 pieces.



Barrier hoop **PA07406**

PLASTIC CHAIN

- Made of UV resistant high density polyethylene.
- Helps to direct traffic in the right direction.
- Size Ø: 50 mm.

White	25 mtr.	DU39800
Red	25 mtr.	DU39801
Yellow	25 mtr.	DU39802
Black	25 mtr.	DU39803
Green	25 mtr.	DU39804
White / red	25 mtr.	DU39805
Yellow / black	25 mtr.	DU39806
Green / white	25 mtr.	DU39807



BRAIDED POLYPROPYLENE ROPE

- On 300 mtr. spools.
- Size Ø: 6,4 mm.

Yellow	PA12950
White	PA12954
Hunter green	PA12958
Hunter green / white	PA12962
Black	PA12956



- HAZARD MARKERS -



PVC HAZARD MARKERS WITH SPIKES

- Economical and easy to use.
- Virtually unbreakable.
- Caps included.
- Size: 63 cm plus 11 cm steel spike.
- Weight: 0,45 kg.
- Carton: 12 pieces.

White	CA27311
Yellow	CA27336
Red	CA27361
Blue	CA27386



TEAK HAZARD MARKERS

- Made from teak wood.
- With stainless steel spike.
- Size: 60 x 5 x 5 cm.
- Carton: 5 pieces.

DU82325
Please state colour.



RECYCLED PLASTIC ROUND HAZARD MARKERS WITH SPIKE

- Molded, UV resistant colours won't fade or chip.
- Won't absorb moisture, crack or rot.
- Size: 60 cm plus 13 cm steel spike.
- Carton: 12 pieces.

White	SG16600
Yellow	SG16625
Red	SG16650
Blue	SG16675



RECYCLED PLASTIC SQUARE HAZARD MARKERS WITH SPIKE

- Molded, UV resistant colours won't fade or chip.
- Will not absorb moisture, crack or rot.
- Size: 60 cm plus 13 cm steel spike.
- Carton: 12 pieces.

White	SG16400
Yellow	SG16425
Red	SG16450

- HAZARD MARKERS & TRAFFIC CONTROL -



Made of fully colour-impregnated recycled plastic, they need no maintenance, they are fade resistant and they float.

- Hazard and out-of-bounds markers measure 3,8 x 3,8 cm. The sturdy stainless steel spikes measure 1 cm in diameter.

HAZARD MARKERS WITH SPIKE

- Carton: 25 pieces

45 cm with spike
Red **PA11430**
Yellow **PA11433**

60 cm with spike
Red **PA11436**
Yellow **PA11439**
Blue **PA11437**

HAZARD MARKERS POINTED

- Carton: 25 pieces

60 cm pointed
Red **PA11466**
Yellow **PA11469**



OUT-OF-BOUNDS MARKERS WITH SPIKE

- Carton: 25 pieces

45 cm with spike
White **PA11618**

60 cm with spike
White **PA11620**

85 cm with spike
White **PA11623**



GREEN HAZARD MARKER END CAPS

- Easily add a green top to an existing or new hazard marker.
- Come in boxes of 25 pieces.
- Perfect fit to Par Aide hazard markers.
- Length end caps: 10 cm.

Green hazard marker end caps, box of 25 **PA11699**

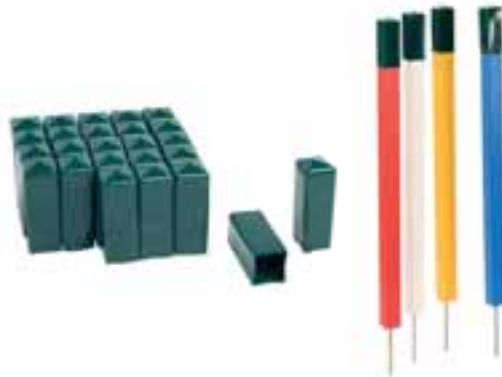

GREEN & WHITE DIRECTIONAL MARKERS

- Easy to place and remove, these multipurpose markers are extremely helpful for guiding golfers in the right direction and around the course.
- Durable 20,3 cm recycled plastic white stakes with a 10,2 cm hunter green vinyl cap.
- Maintenance free.
- Sturdy stainless steel spike measures 0,8 cm in diameter.
- Versatile – direct cart and foot traffic, protect wet areas and new sod, place in front of greens etc.
- Sold only in quantities of 25, including a carrying / storage bucket.

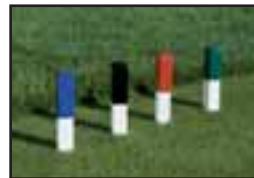

COMPLETE BUCKET OF 25 PIECES

Green & White Directional markers **PA12250-25**
Red & White Directional markers **PA12251-25**
Black & White Directional markers **PA12252-25**
Blue & White Directional markers **PA12253-25**

- TRAFFIC CONTROL -



ROPE STAKES

- Available in two colours and three sizes.
- Carton: 25 pieces

Green 30 cm **PA12200**
 Green 45 cm **PA12210**
 Green 60 cm **PA12230**

White 30 cm **PA12202**
 White 45 cm **PA12212**
 White 60 cm **PA12232**

Black 45 cm **PA12213**
 Brown 45 cm **PA12214**



Nicely shaped top.



Stainless steel spike.



DELUXE STEEL COMBO ROPE & CHAIN STAKES

- Stakes allow the user to string across either rope or chain.
- Stake measures 0,95 cm in diameter.
- With 25,4 cm spike.
- Available in three colours and two sizes.
- Carton: 12 pieces.

Yellow 63,5 cm **SG38320**
 Yellow 91,44 cm **SG38420**

Green 63,5 cm **SG38330**
 Green 91,44 cm **SG38430**

Chrome 63,5 cm **SG38310**
 Chrome 91,44 cm **SG38410**

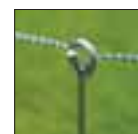
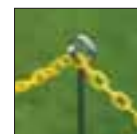

STANDARD GOLF COMPANY

STEEL ROPE STAKES

- Stake measures 0,78 cm in diameter.
- With 14,6 cm spike.
- Positions easily with foot pressure.
- Powder coated finish for durability.
- Available in two colours and two sizes.
- Carton: 12 pieces.

Yellow 35 cm **SG37400**
 Yellow 80 cm **SG37500**

Green 35 cm **SG37450**
 Green 80 cm **SG37550**



- TRAFFIC CONTROL -



**STANDARD
GOLF COMPANY**

RECYCLED PLASTIC SQUARE ROPE STAKE

- Slot designed for 0,65 cm braided rope.
- Won't absorb moisture, crack or rot.
- Available in green and black.
- With 14 cm steel spike.
- Carton: 12 pieces.

30 CM

- Green **SG37850**
- Black **SG37875**

50 CM

- Green **SG38050**
- Black **SG38075**

60 CM

- Green **SG37950**
- Black **SG37975**



TEAK ROPE STAKE

- Made from teak wood.
- Diameter: 5 cm.
- With stainless steel spike.
- Carton: 5 pieces.

- 45 cm **DU82318**
- 60 cm **DU82319**



**STANDARD
GOLF COMPANY**

RECYCLED PLASTIC ROUND ROPE STAKES

- Slot designed for 0,65 cm braided rope.
- Won't absorb moisture, crack or rot.
- Available in green.
- Diameter: 3,8 cm.
- With 14 cm steel spike.
- Carton: 12 pieces.

30 CM

- Green **SG38160**

50 CM

- Green **SG38360**

60 CM

- Green **SG38260**



TEAK CHAIN STAKE

- Made from teak wood.
- Diameter: 5 cm.
- With stainless steel spike.
- Carton: 5 pieces.

- 45 cm **DU82323**
- 60 cm **DU82324**

- DIVOT MIX CONTAINERS -



DIVOT MIX CONTAINERS

The average golfer leaves about 12 ball marks during a typical round of golf. With a daily average of 160 rounds on a typical golf course, your greens will suffer 1.920 ball marks each day and 58.400 ball marks per month equaling to more than 700.000 ball marks each year. Further, consider that the average number of divots a typical golfer creates during a round of golf is 45. This equates to 7.200 divots a day or 2.628.000 divots each year.

To empower the golfers to repair their marks it is imperative to always have the proper tools on hand: a ball-mark repair tool, topdressing material and a scoop.



DIVOT PRO TEAK

- For waste and divot repair Pattison has created unique Teak bins with solid hinged lids for easy accessibility.
- Extremely robust.
- Teak.
- Size: 53 x 37 x 37 cm.

Divot Pro

DU82302



DIVOT PRO JR.



- Recycled plastic wood slats are rustproof, fade resistant and maintenance free.
- Low profile contributes to uncluttered look on tee box.
- 18,9 litre plastic inner bin easily removable for cleaning, filling or changing.
- Weight: 6,8 kg.
- Height: 33 cm.
- Length: 48,3 cm.
- Width: 38,1 cm.

Divot pro Jr. Hunter Green

PA3420

Divot pro Jr. Black

PA3421

Divot pro Jr. Redwood

PA3422

Divot pro Jr. Caramel

PA3423

Colours:

Hunter Green, Black, Redwood & Caramel



- DIVOT MIX CONTAINERS -



DIVOT MATE

- Functionality and economy are the guiding forces behind the Divot Mate divot mix containers. They are available with different stand heights so you can choose where you position them.
- Polyethylene construction prevents denting and rusting.
- Durable frame construction, either powder coated steel or anodised aluminium.
- Large: 15 litre capacity.

DIVOT MATE CONTAINER (NO STAND)

- Includes a 10 cm spike for additional stability on the ground.
- Weight: 2,3 kg.

Black
Hunter green

PA425-00
PA425-02



HARD SURFACE STAND ONLY
PA470



LOW STAND ONLY
PA3030



WALL MOUNT BRACKET
PA475

Ground mounting spike
also available but not
shown.

GROUND MOUNTING SPIKE (4)
PA457-4

SEED AND SOIL CADDY WITH SPIKED HOLDER

- Contoured bottle keeps mixture dry.
- Steel powder-coated holder.
- 13 cm spike holds caddy firmly in place.
- Screw-on cap on bottom for easy filling.
- Decal reminds players to fill divots.
- Size: 34 x 13 cm.
- Capacity: 2,2 litre.
- Carton: 4 pieces.

STANDARD
GOLF COMPANY

Black
Green
Bottle with lid only
Lid only

SG18800
SG18900
SG18802
SG18803



- LITTER BINS -



TEAK SERIE SQUARE LITTER BIN

- Made of top quality teak wood.
- Teak wood harvested along the international regulations regarding conserving the forest by replanting trees.
- Hand-Made to get that original, traditional look.
- Maintenance-free and long lasting.
- 3 years warranty (ask for details).
- Hinged lid permits easy removal of the plastic trash can.
- Including 35 litre trash can.
- Height: 80 cm.
- Width: 44 cm.
- Length: 52 cm.

DU82316



BALL WASHER ATTACHMENT TEAK

Set of 2

DU82303



Teak ensemble with Par Aide ball washer.



Teak ensemble with Standard Golf ball washer.

- LITTER BINS -



THE TRASH MATE®

- The design and construction of the Trash Mate® receptacles reflects a thorough understanding of the golf course environment.
- Polyethylene impervious to rusting and denting.
- Capacity: 35 litre, also accepts trash bag liners.
- Windproof, snap-on lids available in three styles, all black: solid (no opening) to resist pests; trash opening; and "Cans Only" opening.
- Convenient attachment to ball washer pipe reduces number of object to be moved before mowing.
- Flexible design allows you to add a second receptacle for recycling.
- Stackable / nesting design saves storage space.



- LITTER BINS -



Double and single receptacle hardware is suitable for both wall and pipe mounting.

TRASH MATE TRASH SINGLE UNIT

- Comes with one trash opening lid and all necessary mounting hardware.
- Weight: 4 kg.



Black	PA3005-00
Red	PA3005-01
Hunter Green	PA3005-02
Blue	PA3005-03

MOUNTING PIPE



Aluminium mounting pipe 31 cm	PA209-00
Aluminium mounting pipe 61 cm	PA212-00
Aluminium mounting pipe 87 cm	PA210-00
Aluminium mounting pipe 122 cm	PA211-00
Aluminium mounting pipe cap	DU31002

TRASH MATE TRASH DOUBLE UNIT

- Includes two different lids: "Cans Only" and trash and all necessary mounting hardware.
- Weight: 7,2 kg.



Black	PA3001-00
Red	PA3001-01
Hunter Green	PA3001-02
Blue	PA3001-03

- LITTER BINS -



CONTAINER LIDS

• Weight: 0,40 kg.

- Cans lid **PA3010**
- Trash lid **PA3011**
- Solid Lid **PA3012**



Cans



Solid



Trash

CONTAINERS

• Weight: 1,40 kg.

- Black bottom container **PA3014-00**
- Red bottom container **PA3014-01**
- Hunter Green bottom container **PA3014-02**
- Blue bottom container **PA3014-03**



- COMPLETE MOUNTING KIT **PA3019**
- BACK CLAMP ONLY **PA3018**
- MOUNTING BRACKET ONLY **PA3016**
- HOOP FRAME ONLY **PA3015**
- HARDWARE **PA3017**
Not shown



WALL MOUNT BRACKET

- For every vertical surface.
- Weight: 0,9 kg.

Black **PA475**



LOW STAND

- Makes Trash Mate receptacles freestanding.
- Weight: 0,9 kg.

Black **PA3030**



IN GROUND STAND

- Double spikes keeps the trash mate in place and sturdy.

Black **PA3031**

- LITTER BINS -



TRASH PRO 10

- Hinged lid permits easy removal of the 38 litre plastic can (included).
- Accepts 38 litre plastic trash can liners.
- Weight: 9 kg.
- Height: 84 cm.
- Width: 36 cm.
- Length: 46 cm.

TRASH PRO 20

- Hinged lid allows easy removal of the 76 litre plastic can (included).
- Accepts a 76 litre plastic trash can liners.
- Weight: 11 kg.
- Height: 81,3 cm.
- Width: 50,8 cm.
- Length: 50,8 cm.

Colours: Hunter Green, Black, Redwood & Caramel



Hunter Green
Black
Redwood
Caramel

Trash Pro 10

PA3820
PA3821
PA3822
PA3823

Trash Pro 20

PA3830
PA3831
PA3832
PA3833



PATTISSON TECHNOWOOD LITTER BIN

- Fixated lid to prevent blowing open.
- Hinged door for easy emptying of trash can.
- Height: 82 cm.
- Width: 45 cm.
- Length: 45 cm.
- Trash can contains 40 litre.



Hinged door for easy emptying of trash can.

Brown
Green
White

P78310
P78311
P78312



LITTER CADDIES™

- Shaped to properly contain trash contents.
- 20-gauge steel with rich, durable powder-coated finish.
- Size: 34 litre.
- Comes with a sandy soil caddy spike.



Red **SG13150**
Blue **SG13175**
Yellow **SG13400**
Green **SG13700**
Black **SG13195**



ROUND BASE

Stainless steel base **SG13202**

- LITTER BINS -



MILTONA RECYCLED PLASTIC DOUBLE TRASH CONTAINER

- Built of heavy duty recycled plastic.
- Comes with double plastic liner bin of 50 litre each.
- Hinged heavy duty lid.
- Height x Width x Length: 90 x 46 x 82 cm.

Green	MT625665
Brown	MT625666
Black	MT625667



PATTISSON TECHNOWOOD LITTER BIN - TRIPLE

- Built of heavy duty recycled Technowood.
- Comes with 3 metal trash cans of 40 litre each.
- Hinged doors for easy emptying of trash cans.
- Fixated lid to prevent from blowing open.
- Height x Width x Length: 82 x 45 x 132 cm

Brown	P78320
Green	P78321
White	P78322



PATTISSON TECHNOWOOD LITTER BIN - 4-COMBO

- Built of heavy duty recycled Technowood.
- Comes with 4 metal rings to hold any 25 litre plastic bag.
- Hinged 2-sided top for easy removal of plastic bags.
- Height x Width x Length: 82 x 60 x 63 cm.

Brown	P78330
Green	P78331
White	P78332



- WATER PRO -



WATER PRO

- Double door and a built-in locking system make the cooler easily accessible.
- Features large capacity and ample cup storage, plus an onboard trash receptacle for use with large plastic trash bags.
- Front access to cooler gives you the flexibility to locate the water cooler where it's most needed.
- Weight: 87 kg.
- Height: 173 cm.
- Width: 71 cm.
- Depth: 56 cm.

WATER PRO COMPLETE

- Includes station, trash bag frame, 38 litre Hunter Green Igloo® water cooler and Igloo® cup dispenser.

Hunter Green	PA3620
Black	PA3621
Redwood	PA3622
Caramel	PA3623

WATER PRO STATION ONLY

- Includes station and trash bag frame.

Hunter Green	PA3610
Black	PA3611
Redwood	PA3612
Caramel	PA3613

WATER PRO STATION ACCESSORIES (not shown)

Igloo® Water cooler – Hunter Green	PA3657
Igloo® Cup dispenser	PA3658
Cone shaped paper cups – 5.000	PA3659
Trash recycling kit	PA3661



Trash recycling kit



Colours: Hunter Green, Black, Redwood & Caramel



WATER PRO JR.

- Post-mounted water cooler station can be conveniently located virtually anywhere on the course.
- Features locking door with front access.
- Constructed from maintenance-free 100% recycled plastic material.
- Mounting post is 15 x 15 x 183 cm recycled plastic.

Hunter Green	PA3632
Black	PA3633
Redwood	PA3634
Caramel	PA3635



- TEE TOWELS -



TRIFOLD COTTON VELOUR TEE TOWELS

- Add class to the ball washer with the trifold Pattisson tee towels.
- Made from cotton velour.
- Superior quality - can be washed and re-used.
- Available in black and green.
- Comes with an embroidered Pattisson logo.

Hunter Green, per dozen **CA15070**
 Black, per dozen **CA15071**



TRIFOLD COTTON TEE TOWELS

- Re-usable.
- With brass grommet.
- Size: 45,6 x 45,7 cm.
- Weight: 0,075 kg.
- Packed per dozen (carton = 12 dozen).

Hunter Green, per dozen **PA403**
 Black, per dozen **PA405**



TEE TOWELS

- Duo-fold.
- Size: 18 x 52 cm.
- Weight: 0,016 kg.
- Packed per 200 pieces.



ECONOMY TEE TOWELS

Lime green / white per 200 pcs **SG04969**

CHIX® DISPOSABLE TEE TOWEL

Green / white per 200 pcs **SG04965**

CHIX® WASHABLE TEE TOWELS

Green per 200 pcs **SG04970**



- RENTAL TROLLEYS -

RENTAL TROLLEYS

- Robust all steel trolley for heavy duty rental use.
- Easy to remove bag holder for rental purposes.
- Colour: Black.
- Available with 2 and 3 wheels.
- Packed: per 2 pieces.

Rental trolley, 2 wheels **LE4101010**

Rental trolley, 3 wheels **LE4101013**

Accessories

Upper Bracket **LE4101011**

Wheel **LE4101012**

Front Wheel **LE4101014**



Rental trolley, 2 wheels



Rental trolley, 3 wheels

- PLAIN FLAGS -



PATISSON HOLE FLAGS - ALL HIGH STANDARDS IN 1 PRODUCT

See page 121 for printed flags.

PATISSON FLAGS

- 400 denier white, yellow and red nylon as a standard quality for that rich look and feel.
- UV and waterproof finish for maximum colour stability and durability.
- Quadruple-edge stitching extends the life of the flag.
- Available in tube-lock version.
- Size: 36 x 50 cm.



TUBE LOCK SOLID COLOUR FLAGS (PER SET OF 9)

		400 DENIER
	SOLID WHITE	P409001
	SOLID YELLOW	P409002
	SOLID RED	P409003
	SOLID BLUE	P409004

Add an X for a single flag order

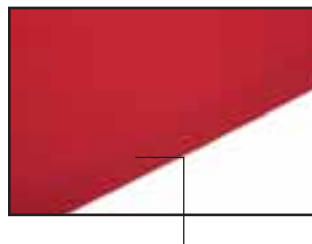

Quadruple-edge stitching extends the life of the flag.

- NUMBERED FLAGS -



PATTISSON HOLE FLAGS - ALL HIGH STANDARDS IN 1 PRODUCT

- 400 denier white, yellow and red nylon as a standard quality for that rich look and feel.
- UV and waterproof finish for maximum colour stability and durability.
- Quadruple-edge stitching extends the life of the flag.
- Available in tube-lock version.
- Size: 36 x 50 cm.

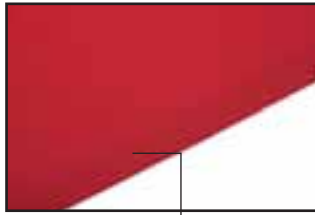

Quadruple-edge stitching extends the life of the flag.

TUBE STYLE LOCK NUMBERED FLAGS (PER SET OF 9)



RED WITH WHITE NUMBERS

- 1-9 **P409005**
- 10-18 **P409006**



WHITE WITH GREEN NUMBERS

- 1-9 **P409013**
- 10-18 **P409014**



WHITE WITH RED NUMBERS

- 1-9 **P409007**
- 10-18 **P409008**



WHITE WITH BLACK NUMBERS

- 1-9 **P409015**
- 10-18 **P409016**



YELLOW WITH BLACK NUMBERS

- 1-9 **P409009**
- 10-18 **P409010**



RED WITH WHITE NUMBER SINGLE

P409019



WHITE WITH BLUE NUMBERS

- 1-9 **P409011**
- 10-18 **P409012**



WHITE WITH RED NUMBER SINGLE

P409020







- PLAIN FLAGS -



PAR AIDE FLAGS

- Improved steadfast colours, thanks to a patented DuPont® process.
- Stronger stitching, including bar-tacked corners and four rows of fly-hem stitching ensures durability in high winds.
- Also available in a 400 denier version, a heavier and more durable construction.
- Size: 36 x 50 cm.

TUBE STYLE SOLID-COLOUR FLAGS (PER SET OF 9, OR AS SINGLE)

	200 Denier	400 denier
 SOLID RED	<i>PA8102</i>	<i>PA8200</i>
 SOLID WHITE	<i>PA8112</i>	<i>PA8201</i>
 SOLID BLUE	<i>PA8122</i>	<i>PA8202</i>
 SOLID YELLOW	<i>PA8132</i>	<i>PA8203</i>
 SOLID ORANGE	<i>PA8142</i>	
 SOLID GREEN	<i>PA8162</i>	<i>PA8204</i>
 COLOUR FLAG SET (3 red, 3 white and 3 blue)	<i>PA8126</i>	<i>PA8210</i>

Add an X for a single flag order.













STANDARD GOLF FLAGS

- Material: nylon.
- Size: 36 x 50 cm.



TUBE STYLE SOLID-COLOUR FLAGS (PER SET OF 9, OR AS SINGLE)

BELOW COLOURS ONLY SOLD PER SET OF 9

 SOLID WHITE	<i>SG22200T</i>	 SOLID MAROON	<i>SG22380T</i>
 SOLID YELLOW	<i>SG22210T</i>	 SOLID BLACK	<i>SG22410T</i>
 SOLID RED	<i>SG22190T</i>	 SOLID PINK	<i>SG22420T</i>
 SOLID ORANGE	<i>SG22220T</i>	 SOLID PURPLE	<i>SG22350T</i>
 SOLID LIGHT BLUE	<i>SG22340T</i>		
 SOLID MEDIUM BLUE	<i>SG22250T</i>		
 SOLID DARK BLUE	<i>SG22260T</i>		
 SOLID GREEN	<i>SG22280T</i>		

Add an X for a single flag order.

- NUMBERED FLAGS -



PAR AIDE NUMBERED FLAGS

- Improved steadfast colours, thanks to a patented DuPont® process.
- Stronger stitching, including bar-tacked corners and four rows of fly-hem stitching ensures durability in high winds.
- Size: 36 x 50 cm.
- Per set of 9.

WHITE ON RED

Nylon	1-9	<i>PA8302</i>
Nylon	10-18	<i>PA8304</i>

RED ON WHITE

Nylon	1-9	<i>PA8312</i>
Nylon	10-18	<i>PA8314</i>

BLACK ON YELLOW

Nylon	1-9	<i>PA8332</i>
Nylon	10-18	<i>PA8334</i>

WHITE ON BLUE

Nylon	1-9	<i>PA8322</i>
Nylon	10-18	<i>PA8324</i>



STANDARD GOLF NUMBERED FLAGS

- Made of nylon.
- Size: 36 x 50 cm.
- Per set of 9.



WHITE WITH RED NUMBERS

1-9	<i>SG22111T</i>
10-18	<i>SG22110T</i>



RED WITH WHITE NUMBERS

1-9	<i>SG22101T</i>
10-18	<i>SG22100T</i>



WHITE WITH BLUE NUMBERS

1-9	<i>SG22141T</i>
10-18	<i>SG22140T</i>



YELLOW WITH BLACK NUMBERS

1-9	<i>SG22121T</i>
10-18	<i>SG22120T</i>



WHITE WITH GREEN NUMBERS

1-9	<i>SG22161T</i>
10-18	<i>SG22160T</i>



BLUE WITH WHITE NUMBERS

1-9	<i>SG22151T</i>
10-18	<i>SG22150T</i>

- CHECKERED FLAGS -

PATTISSON 400 DENIER CHECKERED FLAGS - THE KING OF FLAGS!

- 400 denier white, black, yellow and red nylon as a standard quality for that rich look and feel.
- UV and waterproof finish for maximum colour stability and durability.
- Quadruple-edge stitching extends the life of the flag.
- Available in tube-lock version.
- Size: 36 x 50 cm.



TUBE LOCK SOLID COLOUR CHECKERED FLAGS (PER SET OF 9)

 RED & WHITE *PA409021*

 BLACK & WHITE *PA409023*

 YELLOW & BLACK *PA409024*

Add an X for a single flag order



TUBE LOCK CHECKERED FLAGS (PER SET OF 9)

- Made of nylon.
- Size: 36 x 50 cm.

 RED & WHITE *PA8502*

 BLUE & WHITE *PA8512*

 BLACK & WHITE *PA8522*

 BLACK & YELLOW *PA8532*

 GREEN & WHITE *PA8562*



Finish your flags with your club logo inside the open-center design. Made to order, if you do not exactly see what you want in this catalog. No problem. Call today and ask about customizing your flag order.

TUBE LOCK SEMAPHORE FLAGS (PER SET OF 9)

- Made of nylon.
- Size: 45 x 33 cm.

Red & White *SG22300T*
 Black & White *SG22400T*
 Medium blue & White *SG22450T*
 Green & White *SG22470T*
 Black & Yellow *SG22480T*

Red & White dual numbers *SG22310T*
 Pennant red & white *SG22290T*



- PRINTED & EMBROIDERED FLAGS -



FULL TAILORED PRINTED FLAGS

Duchell can provide an All-inclusive for fully customised double sided printed flags:

- Available with full coverage colours and graphics.
- Possibility of different print on back side.
- 400D Nylon with reinforced corner stitching.

Double sided printed flags **DU66012**

The same print on each side

Surcharge for different print on each side **DU66015**



Different print on back side.



EMBROIDERED FLAGS

1. All-inclusive concept: price includes flag, artwork, and embroidery.

Single sided **DU66001**

Double sided **DU66002**

2. Surcharge for individual numbering on request.

Delivery time for embroidered flags 2-3 weeks.



Detailed embroidery.

- PRINTED FLAGS -



PRINTED PATTISSON 400 DENIER WHITE HOLE FLAGS - THE NEW GENERATION!

- Sublimation print allows full colour reproduction with photo quality.
- Maximum durability and stability of print due to the ink penetrating into the fibers of the flag.
- UV and waterproof finish for maximum colour stability and durability.
- Quadruple-edge stitching extends the life of the flag.
- Possibility for single sided and double sided printing.
- Size: 36 x 50 cm.



SUBLIMATION PRINT ON WHITE 400 DENIER TUBE LOCK FLAGS

Set up charge	DU61008
Full colour print per flag	DU61007
Surcharge for individual numbering	DU61009
Flag 400 D polyester white - Set	P409025
Flag 400 D polyester white - Single	P409025X
Double sided Flag 400 D polyester white - Set	P409027
Double sided Flag 400 D polyester white - Single	P409027X

See page 149 for junior printed flags.

Experience the fastest turnaround. Once we have final logo approval, please allow 5 working days for delivery.



Maximum durability and stability of print due to the ink penetrating into the fibers of the flag.

- FLAGSTICKS -



PATTISSON PRO FLAGSTICK

- Flagsticks covered with a Vinyl sleeve that is shrunk to fit the flagstick.
- Extremely durable and will not fade, chip or stain.
- UV rays or chemical will also not affect the colour of these flagsticks.
- Comes with a Pattison Pro ferrule, fits in Pattison Pro Cup.
- Size: 2,19 mtr.

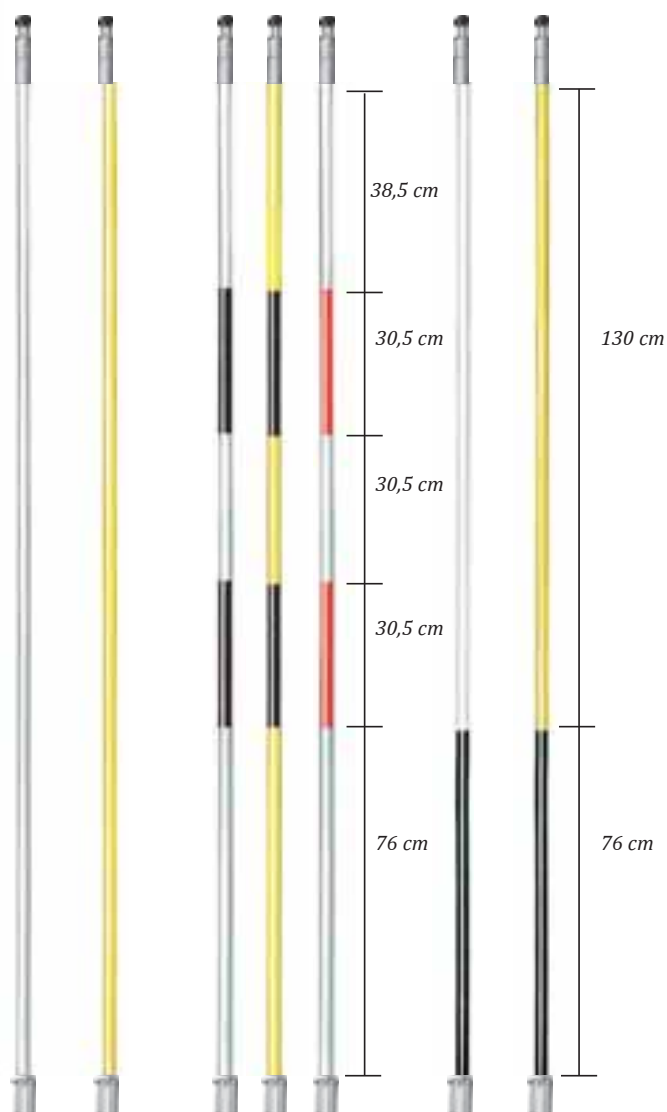

PATTISSON PRO REGULAR Ø 1,3 CM, 2,19 MTR FLAGSTICKS

Pattison Pro White	CA33001
Pattison Pro Yellow	CA33003
Pattison Pro White, 2 Black stripes	CA33002
Pattison Pro Yellow, 2 Black stripes	CA33004
Pattison Pro White, 2 Red stripes	CA33005
Pattison Pro White with Black bottom	CA33006
Pattison Pro Yellow with Black bottom	CA33007

- FLAGSTICKS -



Acorn Nut
CA33220

Extend your flagstick life easily with a replacement ferrule.

PATISSON PRO TOURNAMENT Ø 1,9 CM, 2,19 MTR FLAGSTICKS

Pattison Pro White	CA33101
Pattison Pro Yellow	CA33103
Pattison Pro White, 2 Black stripes	CA33102
Pattison Pro Yellow, 2 Black stripes	CA33104
Pattison Pro White, 2 Red stripes	CA33105
Pattison Pro White with Black bottom	CA33106
Pattison Pro Yellow with Black bottom	CA33107

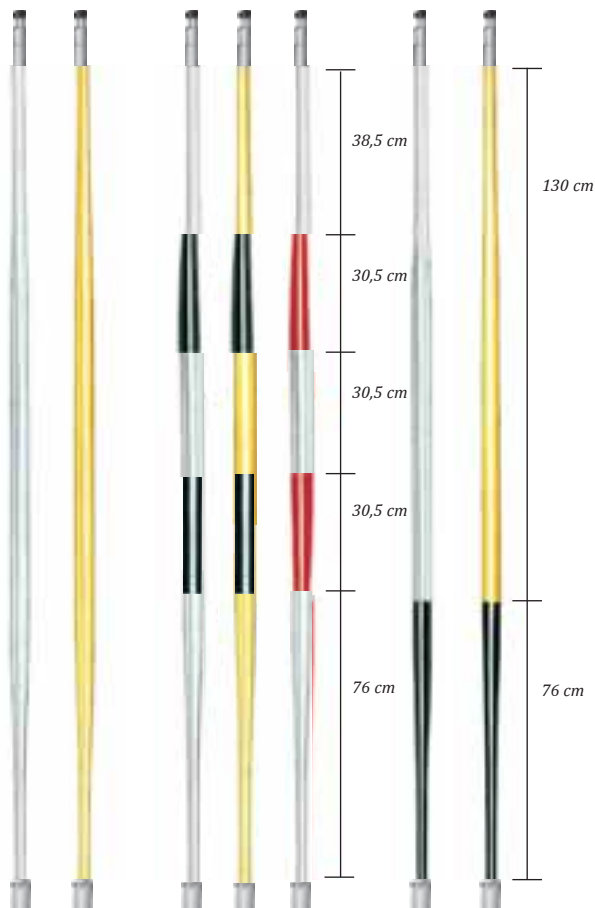

PATISSON PRO QUICK LOCKING PIN

- Quick snap on Pattison flagsticks allows an easy exchange of tube lock flags.
- Fits Pattison flagsticks only.
- 1-piece economical construction.

CA33210



PATISSON PRO FERRULE

- Grooves prevent the flag poles from sticking in the cup.
- Notches prevent the flag poles from turning and stops the flagsticks from twist or lean.
- Comes standard on all Pattison flag poles.
- Perfectly fits the Pattison plastic & aluminium Pro cups.

CA33200



- FLAGSTICKS -

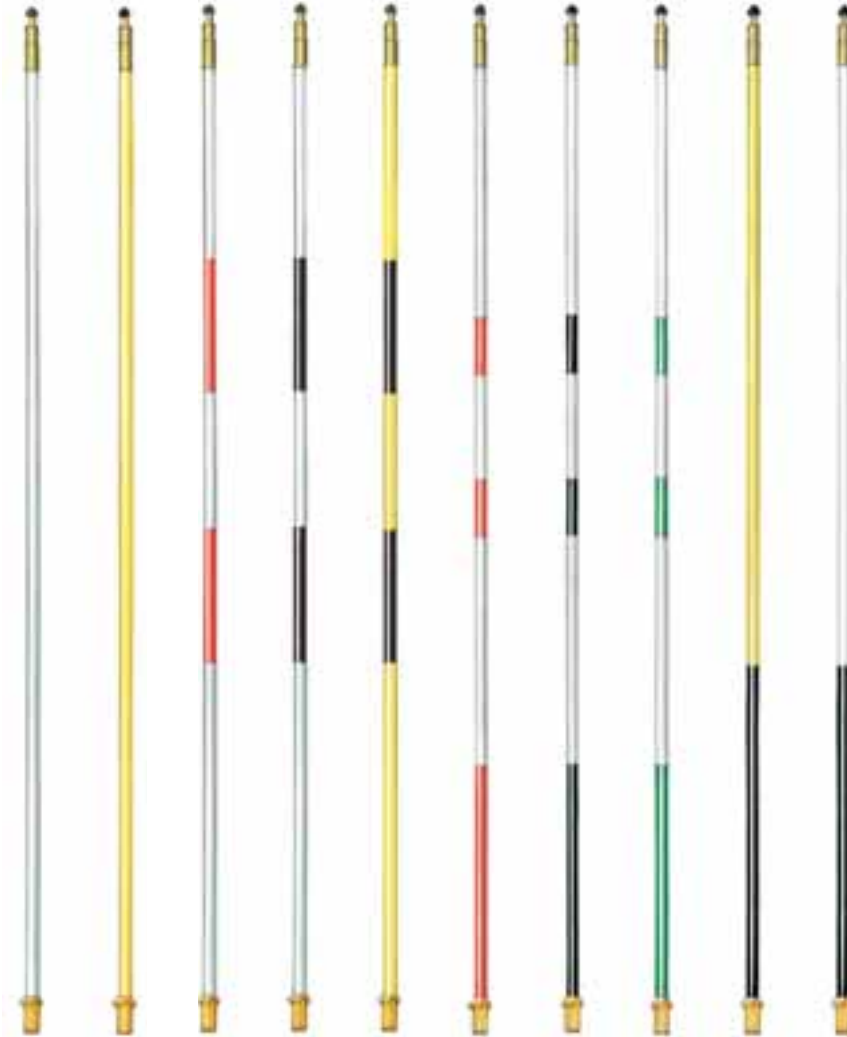

STRIPED REGULATION FIBERGLASS Ø 1,3 CM FLAGSTICKS

	1,50 MTR.	2,29 MTR.	3,05 MTR.
Bright White	PA730-05	PA730-075	PA730-10
Bright Yellow		PA740-075	PA740-10
Red & White, 2 stripe		PA725-075	
Black & White, 2 stripe		PA752-075	
Black & Yellow, 2 stripe		PA747-075	
Red & White, 3 stripe	PA720-05	PA720-075	PA720-10
Black & White, 3 stripe		PA750-075	PA750-10
Green & White, 3 stripe		PA755-075	PA755-10
Bright Yellow with Black bottom		PA745-075	PA745-10
Bright White with Black bottom		PA754-075	

FLAGSTICKS



TAPERED TOURNAMENT FIBERGLASS FLAGSTICKS

More visible and offers a solid and sturdy look and feel. They measure 2,29 mtr and taper from 1,9 cm diameter in the middle.

Extend your flagstick life easily with a replacement ferrule.

TAPERED TOURNAMENT Ø 1,9 CM FIBERGLASS FLAGSTICKS, 2,29 MTR

Bright White	PA706-07
Bright Yellow	PA707-07
British Stripe Black & White	PA708-07
British stripe Red & White	PA712-07
British stripe Green & White	PA713-07
British stripe Black & Yellow	PA714-07
Bright Yellow with 76 cm Black bottom	PA709-07
Bright White with 76 cm Black bottom	PA711-07



Acorn Nut **PA1733-6**
Package of 6

Top Stud **PA1732-6**
Package of 6



Patented Ferrule **PA1729**



QUICK LOCKING PIN

- Quick snap on system allows an easy exchange of tube lock flags.
- Fits any standard flag pole with US thread.
- Consists of brass base and plastic top (order separately).

Quick locking pin, Plastic top **P409225**
Quick locking pin, Brass base **P409226**



- VINYL COVERED FLAGSTICKS -



NEW: pink flagsticks for your ladies or girls tournament or your Pink Ribbon event. Also pink cups and flags available.

PAR AIDE VINYL COVERED

A full line of vinyl-covered flagsticks - your most durable flagstick option. These flagsticks are available in popular colour and striping patterns in both 1,3 cm and 1,9 cm models. All flagsticks come pre-applied with vinyl shrink-wrap coverings to save you time and money when considering a vinyl-covered flagstick option.

Some of the key features:

- Vinyl covered flagsticks last longer and perform better.
- Will not fade, splinter, crack, nick, scratch or stain.
- Protection against damage from abrasion, UV rays, chemicals and the elements.
- Pre-assembled for convenience, no heat gun use required.

STANDARD Ø 1,3 CM VINYL COVERED FLAGSTICKS

2,29 MTR

Bright White	<i>PA730-075-2</i>
Bright Yellow	<i>PA740-075-2</i>
2 Stripe Black & White	<i>PA752-075-2</i>
Bright Yellow with 76,2 cm Black Bottom	<i>PA745-075-2</i>
Pink	<i>PA710-099-2</i>

TAPERED Ø 1,9 CM VINYL COVERED FLAGSTICKS

2,29 MTR

Bright White	<i>PA706-07-2</i>
Bright Yellow	<i>PA707-07-2</i>
British Stripe Black & White	<i>PA708-07-2</i>



- PRISM FLAGSTICKS -

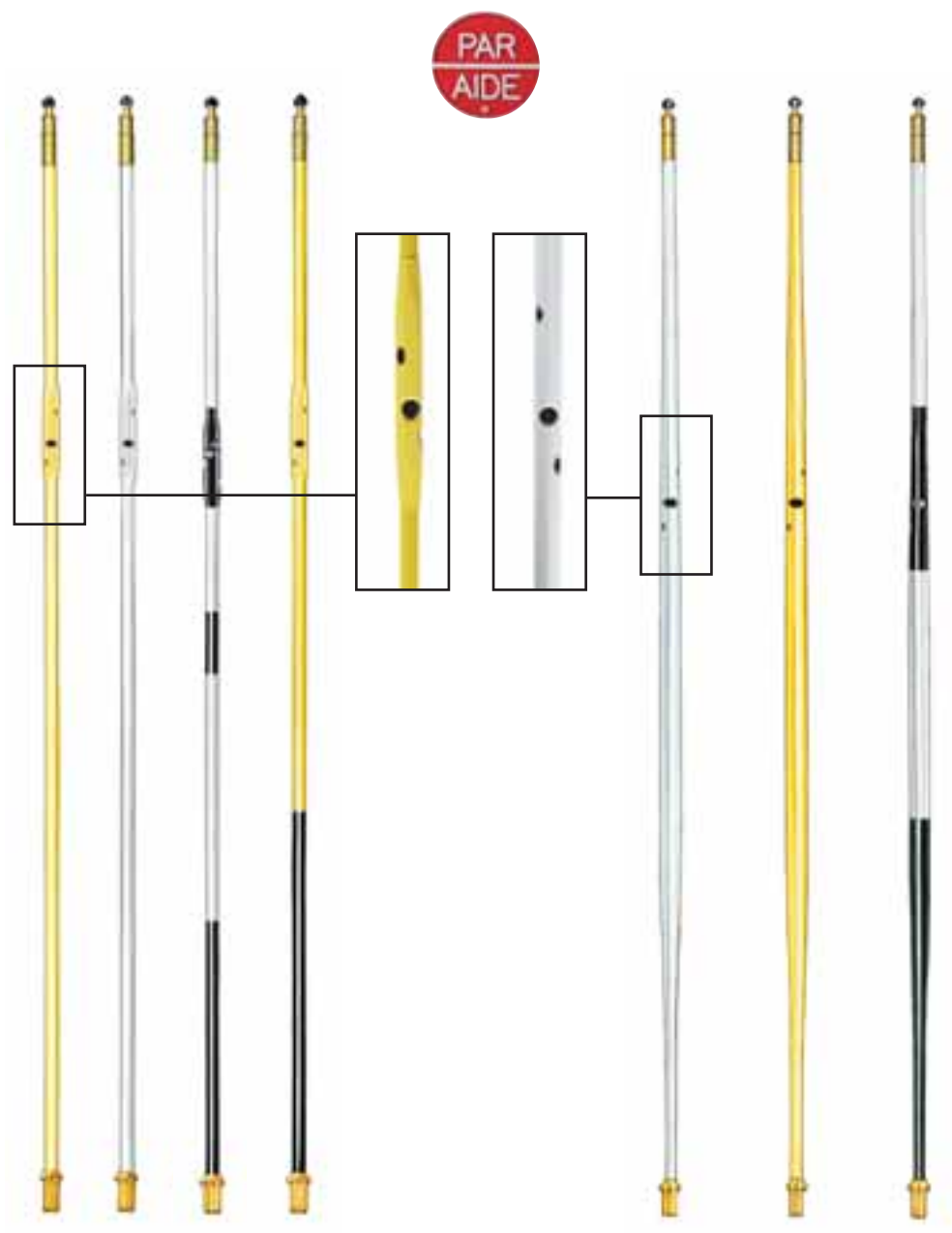

PRISM FLAGSTICKS

The Prism flagstick is here to make laser distance measuring devices easier to use and more accurate on your golf course. The Prism flagsticks integrate the reflecting prisms into the body of the flagstick.

- For use with all laser golf distance measuring devices.
- Premium glass prisms for maximum accuracy.
- Prism flagstick (available in \varnothing 1,3 cm and \varnothing 1,9 cm tapered) are machine drilled, allowing precise insertion of prisms.
- All flagsticks are 2,29 mtr tall.

	STANDARD \varnothing 1,3 CM PRISM FLAGSTICKS	TAPERED \varnothing 1,9 CM PRISM FLAGSTICKS
Bright Yellow	PA740-075-1	PA707-07-1
Bright White	PA730-075-1	PA706-07-1
British Stripe Black & White		PA708-07-1
Black & White, 3 stripe	PA750-075-1	
Bright Yellow with Black bottom	PA745-075-1	

- FLAGSTICKS -



ROYALINE Ø 1,3 CM FLAGSTICKS

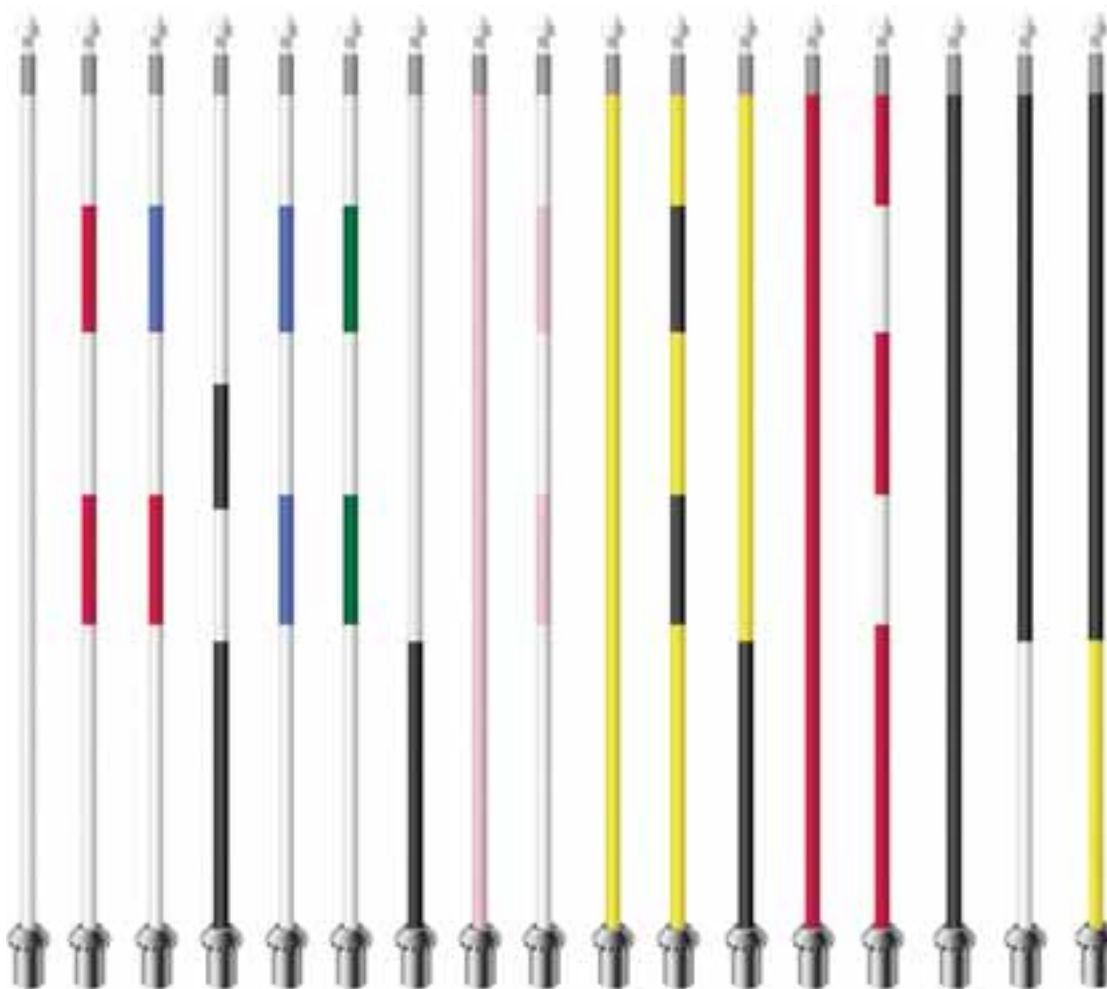

2,29 MTR. TALL

- White **SG26100**
- White / Red Stripe **SG26101**
- White / Blue & Red Stripe **SG26102**
- White / Black British Stripe **SG26103**
- White / Blue Stripe **SG26104**
- White / Green Stripe **SG26105**
- White / Black Bottom **SG26106**
- Pink **SG26107**
- White / Pink Stripe **SG26108**
- Yellow **SG26110**
- Yellow / Black Stripe **SG26111**
- Yellow / Black Bottom **SG26112**
- Red **SG26120**
- Red / White Stripe **SG26121**
- Black **SG26130**
- Black / White Bottom **SG26131**
- Black / Yellow Bottom **SG26132**

1,52 MTR. TALL

- White / Red Stripe **SG26915**
- White **SG26995**

3,05 MTR. TALL

- White / Red Stripe **SG26910**
- Yellow / Black Stripe **SG26911**
- Yellow **SG26980**
- White **SG26990**

ACORN NUT

- Acorn Nut **SG26412**

REPLACEMENT FERRULE

- For all Standard Golf Flagsticks
- SmartFit **SG26512**

- FLAGSTICKS -



TOURNAMENT FLAGSTICKS

Tournament flagsticks feature extra heft in the centre for remarkable strength, visibility and wind resistance. Order with British stripe for added visibility.

- Size: 1,3 cm diameter at the tip and ferrule, 1,9 cm diameter at the middle.

2,29 MTR. TALL

White	SG26300
White / Black British Stripe	SG26301
White / Red British Stripe	SG26302
White / Green British Stripe	SG26303
White / Black bottom	SG26304
Yellow	SG26310
Yellow / Black British Stripe	SG26311
Yellow / Black bottom	SG26314



PUTT-SAVER TOURNAMENT FLAGSTICK

- Smaller diameter at the bottom of the cup than our regular tournament flagstick thus allowing more room for the ball to fall into the cup.
- In addition to the Putt-Saver Technology, this new flagstick will also come in two pieces – saving costs when shipping.
- With a reinforced steel rod and colour fully-absorbed throughout the flagstick, this is the new leader in the clubhouse.

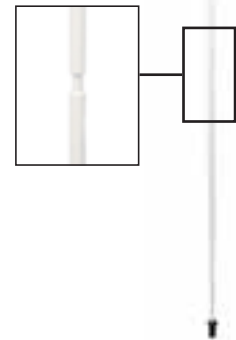

2,29 MTR. TALL

White	SG26350
Yellow	SG26360
White / Black	SG26370
White / Red	SG26380
Yellow / Black	SG26390



QUICK LOCKING PIN

- Quick snap on system allows an easy exchange of tube lock flags.
- Fits any standard flag pole with US thread.
- Consists of brass base and plastic top (order separately).

Quick locking pin, Plastic top	P409225
Quick locking pin, Brass base	P409226



SMART-FIT PRO FERRULE

- Patented solution for pre-mature wear.
- Notched-ferrule flagsticks fall right into place every time.
- Sturdy, gusset-reinforced ribs allow dirt and sand to freely sift through the cup to eliminate sticking.
- 16 tapered flanges seat the ferrule and flagstick perfectly with the Smart-Fit Cup.
- Comes standard on all Standard Golf flagstick orders.
- To help prevent chipping cups or dulling the Smart-Fit finish, the new Smart-Fit ferrules have a polymer base. This base will help increase the life of your cups!

Smart-Fit Pro Ferrule	SG26512
-----------------------	----------------

- WOODEN FLAGSTICK -



ELEGANT ACCESSORIES FOR YOUR GREENS

If you are searching for the most exclusive flagstick available, you have just found the right source.

Perennial flagsticks are an elegant combination of hardwood and brass.

- They are hand crafted, and give years of service with proper care.
- Hardwood sticks, specially cured and finished to withstand any golf environment.
- Shown is a flagstick with a golden brown stain, protected with a clear acrylic topcoat.
- We can apply a no gloss penetrating sealer if you want a "Links" presentation.
- Fiberglass rods are available in black or white, and the stock ferrule is grooved aluminum. On request we can change the ferrule to any Pattisson, Par Aide or Standard Golf ferrule.
- Wood section is 3 cm in the middle and tapers to both brass connectors.
- Various models and color combinations available.

Perennial Tournament flagstick 2,13 mtr wood **DU37060**

Perennial Practice Green Marker wood **DU37062**



- MEASURING SYSTEMS -

RANGE PAL REFLECTORS

The Range Pal Reflector is the perfect, inexpensive and simple solution for accurate distance measurements!

This nifty little cylinder just slides over the flagpole and provides a reliable target, it has a large circular and highly reflective surface which reflects back to the laser rangefinder giving the correct distance to the hole.

No more problems with other background objects confusing the rangefinder and for a reasonable price you can provide members and guests with a handy tool on the golf course.

- Reflector 1,3 cm, set of 9
- Reflector 1,3 cm, piece
- Reflector 1,91 cm, set of 9
- Reflector 1,91 cm, piece

- RP2847**
- RP2848**
- RP2849**
- RP2850**

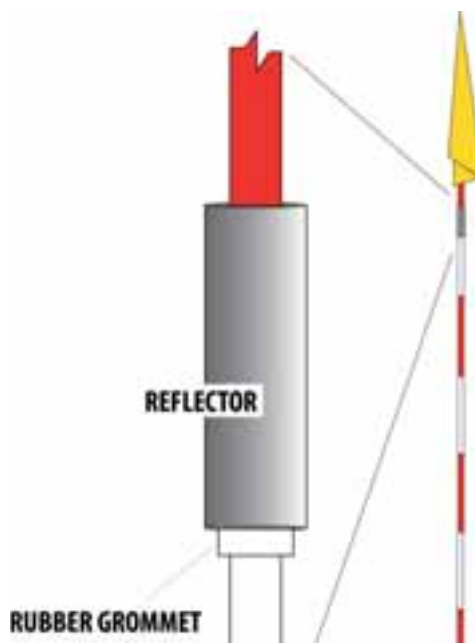

PINSITE REFLECTOR

- Convert any existing flagstick to give precise readings to laser distance measuring devices.
- Screws in place of acorn nut.
- Nylon thread prevents seizing to the top of the flagstick.



Pinsite reflector

PA1736



- PLACEMENT MARKERS -



PLACEMENT FLAGS AND MARKERS

Our placement flags and placement markers make it easy to identify cup positions on the greens. Using a rubber grommet, the tubular flags or markers can be moved up or down to signify that the hole is at the front, centre or back of the green. The flags remind players to "Please Repair Ball Marks".

- Placement flags fit flagsticks up to 1,9 cm diameter.
- Placement markers fit flagsticks up to 1,3 cm diameter. (not available for FatSticks)



PLACEMENT FLAGS (SET OF 9 INCL. GROMMETS)

- Made of nylon.
- Weight: 0,23 kg.
- Size: 12 x 19 cm.

Red for 1,3 cm flagstick **SG05335**
 Yellow for 1,3 cm flagstick **SG05355**

Red for 1,9 cm flagstick **SG05337**
 Yellow for 1,9 cm flagstick **SG05357**

Rubber Grommet for 1,3 cm flagstick **SG05354**
 Rubber Grommet for 1,9 cm flagstick **SG05360**



PLACEMENT MARKERS

- Sold individually with grommet.
- Fits 1,3 cm diameter flagsticks only.
- Weight: 0,04 kg.



Red
SG05350

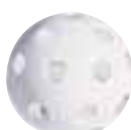

White
SG05351



Blue
SG05352



Yellow
SG05353

- PLACEMENT FLAGS -



Front, middle or back, golfers will know the pin position with the help of these indicators.

- Tube-Style flags - 15,2 x 17,8 cm - held in place by rubber grommets.
- Available for every size of flagstick: 1,3 cm, 1,9 cm and 2,5 cm.
- Solid-colour flags with print "Please Repair Ball Marks" or plain or a custom message.

PLACEMENT FLAGS

FOR Ø 1,3 CM FIBERGLASS FLAGSTICKS (SET OF 9)

Plain Red	<i>PA770-01</i>
Plain White	<i>PA770-02</i>
Plain Yellow	<i>PA770-03</i>
Plain Blue	<i>PA770-04</i>
Red with White printing	<i>PA775-01</i>
White with Red printing	<i>PA775-02</i>
Yellow with Black printing	<i>PA775-03</i>
Blue with White printing	<i>PA775-04</i>



FOR Ø 1,9 CM TAPERED TOURNAMENT FLAGSTICKS (SET OF 9)

Plain Red	<i>PA790-01</i>
Plain White	<i>PA790-02</i>
Plain Yellow	<i>PA790-03</i>
Plain Blue	<i>PA790-04</i>
Red with White printing	<i>PA795-01</i>
White with Red printing	<i>PA795-02</i>
Yellow with Black printing	<i>PA795-03</i>
Blue with White printing	<i>PA795-04</i>

REPLACEMENT GROMMETS (SET OF 9)

For Ø 1,3 cm Flagsticks	<i>PA780-9</i>
For Ø 1,9 cm Flagsticks	<i>PA796-9</i>

- PUTTING CUPS -



Nothing looks worse than a flagstick leaning to one side. This happens when the cup and ferrule get worn out due to windy conditions together with dirt, sand and grit that get in between the ferrule and cup. Often the flagstick gets stuck when golfers try to remove the flagstick from the hole.

WE HAVE THE SOLUTION!

With the Pattisson Pro Cup and the Pattisson ferrule the flagstick will always click into place, meaning that the flagstick cannot turn around in the cup. Also the grooved ferrule makes sure that the dirt and sand pass through the cup leaving the cup and ferrule clean.

No more sticking and flagsticks standing perfectly straight, as they should!

The bright white sleeve can be placed inside the aluminium cup to create a white hole cup, that has the traditional sound of an aluminium cup but without chipped paint. When the white sleeve gets dirty, just replace them.

Or why not personalise the cup with your logo? The ferrule also has the same effect in combination with the Pattisson plastic cup.



-PUTTING CUPS-



PATISSON ALUMINIUM PRO HOLE CUP

- Aluminium.
- Easy to set and fit.
- Pattison pro flagsticks fits perfectly.
- Flagsticks do not lean or turn in cup.
- No chipped paint.
- Size: 15 x 10,8 cm.
- Packed: 9 per carton.

CA29420



SLEEVE PATISSON PRO CUP

- Easy to set and fit.
- Gives the cup a clean white look.
- Can be printed with logo (not a sticker that gets dirty).
- Set of 18.

CA29424 (Set of 18)

LOGO SLEEVE PATISSON PRO CUP

CA29425 (PCS)

CA29426 Set up charge

Minimum quantity logo sleeves: 9 pcs.



PATISSON PLASTIC HOLE CUP

- Brilliant white.
- Made of rugged engineered grade polymers for resistance to chemicals.
- Tapered sides allow easy removal from the hole.
- Size: 15 x 10,8 cm.
- Packed: 9 per carton.

CA29311



PATISSON ALUMINIUM HOLE CUP

- Easy to set and fit.
- Constructed of high grade aluminium.
- Stark white powder coated finish for better visibility.
- Corrosion resistant.
- Virtually unbreakable.
- Size: 15 x 10,8 cm.
- Packed: 9 per carton.

CA29414



- PUTTING CUPS -



Four distinctive styles, each with the hallmark of Par Aide products: durability, great appearance and impeccable quality. Your choices include the brightest white plastic cup in the industry, our traditional machined aluminium cup, and our patented Ever-White Cup, the one you've heard about with replaceable sleeves.

EVER-WHITE CUP

The patented Ever-White™ Cup has revolutionised the category by teaming an aluminium outside with a bright white plastic sleeve.

- No paint to chip, eliminating the need for stripping, sanding and painting.
- Easily replaceable sleeve stays tight in the cup during play.
- Resonates with the classic aluminium sound when the ball drops in.



PATENTED ALUMINIUM CUP COMPLETE WITH PLASTIC SLEEVE

- Meets all USGA regulations.
- Size: 15 x 10,8 cm.
- Weight: 0,9 kg.
- Packed: 9 per carton.

PA935



EVER-WHITE CUP REPLACEMENT SLEEVES

- Case of 18

PA935-1



CUSTOM DECAL FOR EVER-WHITE SLEEVE

Customize your hole cup.

We offer you the option of personalizing your hole cup. Because it is the sleeve that is personalized, it can be easily replaced, for example for a sponsored tournament.

PA520-1

- PUTTING CUPS -



PLASTIC CUPS

- Durable bright white Cicolac® plastic cups featuring minimum taper for a snug fit, both on the course and on the practice green.
- Size: 15 x 10,8 cm.
- Weight: 0,23 kg.
- Packed: 9 per carton.

PA920



PRACTICE GREEN PLASTIC CUPS

- Durable bright Cicolac® plastic cups featuring minimum taper for a snug fit.
- Size: 10 x 10,8 cm.
- Weight: 0,23 kg.
- Packed: 9 per carton.

PA940



ALUMINIUM CUPS

- Our classic model, it's die cast oversize, then machined down to precision dimensions to minimise "wobble" in the hole.
- Surfaces anodised and dichromated for ultimate corrosion protection.
- The cup's vertical surfaces are powder-coated bright white. The bottom of the cup is not powder-coated, so there's no paint to chip.
- Size: 15 x 10,8 cm.
- Weight: 0,9 kg.
- Packed: 9 per carton.

PA930



- PUTTING CUPS -

**STANDARD
GOLF COMPANY**



ST2000™ NON-STICK CUP

The innovative ST2000™ design allows soil to pass down the sides and through the cup. This keeps the cup's socket dirt free and eliminates the ferrule from sticking. Contact points hold the flagstick firmly in place. A dirty ferrule just can not stick in the ST2000™.



PLASTIC ST2000™

- Brilliant white.
- High strength plastic cups.
- Molded with polymers that resist chemicals provide a brilliant, lasting finish.
- Meets all USGA regulations.
- Size: 15 x 10,8 cm.
- Packed 9 per carton.

SG18222



ALUMINIUM ST2000™

- Brilliant white finish.
- Creates a distinctive sound when ball drops.
- Bonderite coated aluminium cups.
- The most chip-resistant coating around.
- Meets all USGA regulations.
- Size: 15 x 10,8 cm.
- Packed 9 per carton.

SG18333



HYBRID ST2000™

- The popular ST2000 Smart-Fit Cup has a third configuration.
- A "hybrid", with an aluminium base and plastic molded walls, combines the best of our aluminium and plastic ST2000 models.
- The aluminium base gives maximum strength as the notched ferrule fits perfectly into place, eliminating twisting, sticking and sinking.
- Plastic molded cup walls prevent chipping and provide a long-lasting finish.
- An aluminium bottom allows for the "traditional sound" of a golf ball hitting the bottom of the cup.
- Meets all USGA regulations.
- Size: 15 x 10,8 cm.
- Packed 9 per carton.

SG18444

- PUTTING CUPS -

**STANDARD
GOLF COMPANY**

RIJI CUP

- Brilliant white.
- Made of rugged engineered grade polymers for resistance to chemicals.
- Tapered sides allow easy removal from the hole.
- Meets all USGA regulations.
- Size: 15 x 10,8 cm.
- Packed 9 per carton.

SG18200



ALUMINIUM CUP

- Easy to set and fit.
- Constructed of high grade aluminium.
- Stark white powder coated finish for better visibility.
- Corrosion resistant.
- Virtually unbreakable.
- Size: 15 x 10,8 cm.
- Packed 9 per carton.

SG18303



PRACTICE GREEN CUP

- Constructed of molded plastic.
- Stronger webs for eliminating warping and assuring a consistently round, easy setting cup.
- Precise inside tolerance holds the practice green marker securely in place.
- Size: 10 x 10,8 cm.
- Packed 9 per carton.

SG18100



ALUMINIUM PRACTICE GREEN CUP

- Bonderie aluminium with the most chip resistance coating around.
- Beveled bottom edge design makes them much easier to insert and remove.
- Size: 10 x 10,8 cm.
- Packed 9 per carton

SG18150



- EVENT CUPS & SURE PUTT -

Please see page 202 for matching hole cutters.



38,1 CM EVENT CUP

Made of durable white plastic to stand up to the elements, it provides an incredibly inviting target for youth and beginning golfers.

Plastic cup Ø 38,1 cm and 7,62 cm high **PA927**



20,2 CM EVENT CUP

Made of durable white plastic to stand up to the elements, it is a great way to grow the game by giving beginners and easier target. Its durability makes it the cup to choose for "Big cup" and junior events.

Plastic cup Ø 20,2 cm and 7,62 cm high **PA925**

**STANDARD
GOLF** COMPANY



SPECIAL EVENT & WINTER CUP

- Powder-coated steel cup in 15,2 cm and 20,2 cm sizes.
- Plastic winter cup available in 20,2 cm.
- Fits standard-sized flagsticks.
- Great addition for "big hole" events.
- Height in 2 sizes: 15 cm and 8 cm.

Steel cup Ø 15,2 cm and 15 cm high **SG18600**

Steel cup Ø 20,2 cm and 8 cm high **SG18700**

Steel cup Ø 20,2 cm and 15 cm high **SG18710**

Plastic cup Ø 20,2 cm and 8 cm high **SG18775**



SURE PUTT PRACTICE GREEN SYSTEM

Putting to the smaller cup, 8 cm diameter compared to a regulation cup (10,8 cm), dramatically helps focus the golfer's aim and trains them to make a more accurate putting stroke.

The Sure Putt Practice Green System is a complete system that is widely regarded as the finest putting aid for any level of golfer.

Offered at a tremendous value, it includes:

- Hole cutter.
- 3 Metal Putting cups 8 x 9 cm.
- Cup puller.
- A sign to explain how the system works.

Complete Sure Putt Practice Green System **PA10710**

Replacement putting cup only **PA10702**

- PUTTING CUPS ACCESSORIES -

CUP COVER

- Rotate cup covers instead of cups during low play seasons.
- Keeps hole free of top dressing material and debris.
- Fits any regulation cup size.
- Fits flush with top of green.
- Available in 3 sizes.
- 10,8 cm cover is power coated steel.
- 15,2 cm and 20,3 cm covers are power coated aluminum.
- Depth: 2,5 cm.

10,8 cm Cup Cover **SG18500**

15,2 cm Cup Cover **SG18650**

20,3 cm Cup Cover **SG18750**

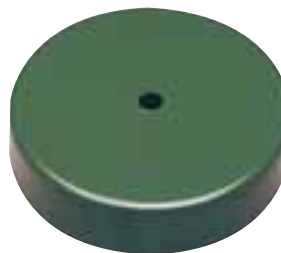

RECYCLED RUBBER CUP COVER

Use these economical, environmentally friendly cup covers instead of rotating cups during low playing seasons or when top dressing.

- Made from recycled tires.
- Fits any regulation size cup.
- Durable, yet won't damage mower wheels if nicked.
- Available in 3 sizes.
- Depth: 2,5 cm.

10,8 cm Cup Cover **CA29455**

15,2 cm Cup Cover **CA29456**

20,3 cm Cup Cover **CA29457**



RESIN CUP COVER

Resin hole cup cover with synthetic grass.

Resin cup cover **PCA559**



CUP PLUGS

- Made from durable, lightweight, weather-resistant foam material.
- Used when aerating greens to protect the integrity of the hole.
- Used when topdressing greens to keep sand from filling up cup hole.
- Can be left in holes during winter months.
- Aeration tines able to penetrate plug without pulling it out of the hole.
- Can be used 2 - 3 times.
- Sold per 9 pieces.

Regulation cup size, pack of 9 pcs **PA1070**

Practice cup size, pack of 9 pcs **PA1071**



COMPLETE PRODUCT RANGE OF THE LATEST RAGE

FootGolf is growing rapidly worldwide and now Duchell offers a complete product line for this sport. Products include the official size FootGolf cup, logo flag, FootGolf tee markers and information signs.

The FootGolf cup is an extremely sturdy cup with an artificial grass top to discretely cover the cup.

In combination with the logo flags, information signs and the eye-catching tee markers, a golf course can create the perfect platform for a wider range of customers.



FOOTGOLF CUP WITH COVER

- Extremely sturdy.
- Lid with artificial grass to cover cup when not in use.
- Official FootGolf size: Ø 52 cm.
- Depth: 35 cm.

CA29600



- FOOTGOLF -

FOOTGOLF TEE MARKER

- Heavy & solid.
- Looks like a miniature football.
- Practically unbreakable.
- Easily stuck into the ground and removed.
- Steel spike.
- Size: Ø 15,5 cm.
- Weight: 3,65 kg.

CA29650



FOOTGOLF DIMPLE TEE MARKER

- Lightweight tee markers.
- Easily stuck into the ground and removed.
- Black golf ball with football image.
- Steel spike.
- Size: Ø 13 cm.
- Weight: 0,29 kg.

CA29685



DIRECTION SIGN INCLUDING ARROW

- Including arrow.
- Clear signage to show players the route.
- Easily stuck into the ground and removed.
- Numbers to be ordered separately.
- Size: 30 x 20 cm.

CA29660

DECALS

Decal numbering 1-9 **CA29661**

Decal numbering 10-18 **CA29662**



FOOTGOLF FLAGS

- High quality polyester flags.
- Sublimation printed FootGolf flags.
- Maximum durability and stability of print.
- UV and waterproof finish.
- Quadruple-edge stitching extends the life of the flag.
- Size 36 x 50 cm.

Set of flags 1-9 **CA29670**

Set of flags 10-18 **CA29671**



- PRACTICE GREEN MARKERS -



Choose your own colour combination.
Order: head, rod en base separately.

Our line of practice green markers allow you to built your own marker to your own liking. Order base, different coloured rods, heads or flags to match your requirements.

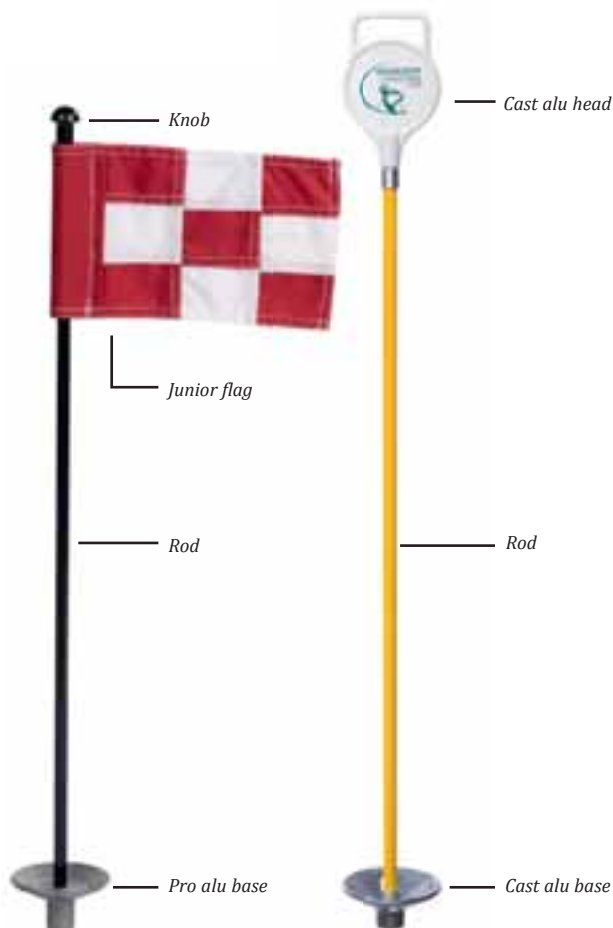

CAST ALUMINIUM PRACTICE GREEN MARKERS

- Available in several attractive powder coated colours.
- Handy built-in grip.
- Full 1,3 cm diameter stick.
- Size: 75 cm.
- Can be personalised with decals featuring logo.
- Order stickers with numbers, in sets only.

FIBREGLASS ROD Ø 1,3 CM

Red	CA31293
Black	CA31393
White	CA31493
Yellow	CA31593
Blue	CA31693
Green	CA31793

METAL BASES

Cast alu base	CA31433
Pattison Pro alu base	CA32100

KNOP FOR PRACTICE GREEN FLAGS

Knob for practice green flag	CA31933
------------------------------	----------------



PATTISSON PRO ALU BASE

- New design aluminium extended base prevents junior flags to 'lean'.
- Bottom ridges for extra stability.

Pattison Pro alu base	CA32100
-----------------------	----------------



Recognize this?



Solution: Pattison Pro alu base

- PRACTICE GREEN MARKERS -



CAST ALUMINIUM HEAD

White	CA31643
Yellow	CA31644
Red	CA31645
Green	CA31646
Blue	CA31647
Black	CA31648



STICKER SETS OF NUMBERS FOR CAST ALUMINIUM MARKERS

- Set of 9 includes two of each number.

Set 1-9, *Please state colour* **CA31652**

Set 10-18, *Please state colour* **CA31651**

Sticker for cast aluminium head

- Diameter stickers 70 mm.

<18 pcs **STICKER DP1**

19-36 pcs **STICKER DP2**

>37 pcs **STICKER DP3**



Cast alu head with personalised sticker or with numbers.

JUNIOR FLAGS

- Size: 20 x 12 cm.

PLAIN JR. FLAGS (Set of 9)

	Red	PA9200
	White	PA9202
	Blue	PA9204
	Yellow	PA9206



Plain flags

CHECKERED JR. FLAGS (Set of 9)

	Red & White	PA9300
	Black & White	PA9320
	Black & Yellow	PA9330
	Green & White	PA9360



Checkered flags

NUMBERED JR. FLAGS (Set of 9)

	White on Red 1-9	PA9251
	White on Red 10-18	PA9252
	Red on White 1-9	PA9261
	Red on White 10-18	PA9262
	Black on Yellow 1-9	PA9281
	Black on Yellow 10-18	PA9282



Numbered flags

PERSONALIZED FLAGS

Personalized (sublimation print or embroidered) versions.
See page 148 and 149.



Personalized flags

KNOP FOR PRACTICE GREEN FLAGS

Knob for practice green flag **CA31933**

- PRACTICE GREEN MARKERS -



JR. FLAGSTICKS

- Made from 1,3 cm fibreglass.
- Non-tip, moulded plastic base for convenient ball extraction.
- Including accorn nut.
- Weight: 0,31 kg.
- Size: 78,7 cm.

Bright White	PA9190
Bright Yellow	PA9191
Red & White	PA9192
Black & White	PA9193
Green & White	PA9194
Black & Yellow	PA9195

Order flags separately.



WOODEN PRACTICE GREEN MARKER

Attract more golfers to the practice green with the handsome Natural Wood Practice Green Markers. Not only do they improve the look of the practice green, these markers complement the classic look of golf.

- Made of extremely strong Brazilian hardwood.
- Flagstick is 86 cm tall for the golfers convenience.
- Finished with natural teak oil. To restore luster, re-apply teak oil periodically.

Wooden practice green marker	PA9120
Optional wooden knob (set of 9)	PA9098-9

EXECUTIVE PUTTING GREEN MARKERS

- Available in red and hunter green, with or without numbers.
- Non-tip designed base.
- Fully assembled.
- Weight: 0,30 kg.
- Size: 83,8 cm.
- Sold in set of 9.



Red plain	PA9170-01
Red 1-9	PA9171-01
Red 10-18	PA9172-01
Hunter Green plain	PA9170-02
Hunter Green 1-9	PA9171-02
Hunter Green 10-18	PA9172-02

- PRACTICE GREEN MARKERS -

EXTRA LARGE PRACTICE GREEN MARKER

- Extra large plastic marker head for better visibility of logo or numbering.
- Available in white only.
- Fits fibre rod & cast aluminium base.
- Head size: 26 x 14 cm.

Plastic marker head only **PC20532**

Fibre rod for plastic marker head **PC20533**

Pattisson Pro alu base **CA32100**

Sticker **STICKERXL**



**STANDARD
GOLF COMPANY**

NUMBERED PRACTICE GREEN PENNANT SETS (SET OF 9)

- Classic, one piece plastic head and fiberglass rod combinations.
- Order them in a set of nine 1-9 or 10-18.
- Rod 1 cm diameter.
- 71 cm long.
- With rod and aluminium base.

Numbered practice green pennant flags

Set 1-9 white / red **SG20391**

Set 10-18 white / red **SG20390**

Set 1-9 white / green **SG20491**

Set 10-18, white / green **SG20490**

Set 1-9 black / yellow **SG20591**

Set 10-18 black / yellow **SG20590**

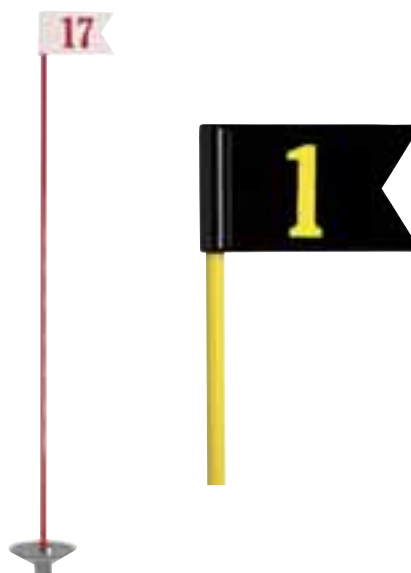

- JUNIOR FLAGS -



JUNIOR FLAGS
• Size: 20 x 12 cm.

PLAIN JR. FLAGS (Set of 9)

- Red **PA9200**
- White **PA9202**
- Blue **PA9204**
- Yellow **PA9206**



CHECKERED JR. FLAGS (Set of 9)

- Red & White **PA9300**
- Black & White **PA9320**
- Black & Yellow **PA9330**
- Green & White **PA9360**



NUMBERED JR. FLAGS (Set of 9)

- White on Red 1-9 **PA9251**
- White on Red 10-18 **PA9252**
- Red on White 1-9 **PA9261**
- Red on White 10-18 **PA9262**
- Black on Yellow 1-9 **PA9281**
- Black on Yellow 10-18 **PA9282**



EMBROIDERED JUNIOR FLAGS

All-inclusive concept: price includes flag, artwork and embroidery.

- Single sided **DU66003**
- Double sided **DU66004**

Surcharge for individual numbering on request.
Delivery time for embroidered flags 2-3 weeks.

- JUNIOR FLAGS -



PRINTED PATTISSON 400 DENIER WHITE HOLE FLAGS - THE NEW GENERATION!

- Sublimation print allows full colour reproduction with photo quality.
- Maximum durability and stability of print due to the ink penetrating into the fibers of the flag.
- UV and waterproof finish for maximum colour stability and durability.
- Quadruple-edge stitching extends the life of the flag.
- Possibility for single sided and double sided printing.
- Size: 25 x 15 cm.

SUBLIMATION PRINT (ON WHITE FLAGS ONLY)

Setting-up charge	<i>DU61008</i>
Full colour print on white junior flag	<i>DU61011</i>
Surcharge for individual numbering	<i>DU61009</i>
Flag 400 D polyester white - Set	<i>P409125</i>
Flag 400 D polyester white - Single	<i>P409125X</i>
Double sided Flag 400 D polyester white - Set	<i>P409127</i>
Double sided Flag 400 D polyester white - Single	<i>P409127X</i>

Experience the fastest turnaround. Once we have final logo approval, please allow 5 working days for delivery.



- BENCHES -



PATTISSON TECHNOWOOD BENCHES

The new Technowood is a product similar to wood but does not present the limitations of the wood itself; it is made out of recycled PVC & Fiberglass and finished with a surface film giving a full 10 year warranty on colour retention and an estimated life of 30 years! No maintenance required at all and endless product possibilities.

The main advantages:

- Impact and pressure resistant.
- Resistant to water, humidity, heat and frost.
- UV resistant with a full 10 year colour retention guarantee.
- Absolutely maintenance free.
- Workability and fixing such as wood.
- Estimated lifetime of 30 years.



BENCH TECHNOWOOD 155 CM COMFORT

- Size: length 155 x width 70 x height 95 cm.
- Seat height: 45,5 cm.

Brown
Green
White

P78214
P78215
P78216



BENCH TECHNOWOOD 147 CM BACKLESS

- Size: length 147 x width 50 x height 45 cm.
- Seat height: 45,5 cm.

Brown
Green
White

P78210
P78211
P78209



- BENCHES -



TEAK BENCHES

The traditional design and classical looks of our range means the products we offer are not just for “on the course” but they also look at home around the clubhouse terrace.

All benches are flat packed (for easy assembly).

- Made of top quality teak wood.
- Teak harvested along the international regulations regarding conserving the forrest by replanting trees.
- Handmade to get that original traditional look.

Walmer bench 180 x 60 cm **MX41013**



For maintenance of the wood, please see page 70.

Junior bench 100 x 45 cm **MX41010**



- ON THE TEE ACCESSORIES -



PAR AIDE COOLER PRO

- Recycled plastic housing - maintenance free.
- Chic, low profile option for keeping refreshments cold on the course.
- Comes complete with a removable Igloo cooler.
- Cooler lid attaches to Cooler Pro for convenience or can be detached to use cooler separately.

COOLER PRO

- Weight 26,8 kg
- Size 68,8 (W) x 45,7 (D) x 48,3 cm (H)
- 36 litre cooler.

Hunter Green **PA3330**

Black **PA3331**

Redwood **PA3332**

Caramel **PA3335**



COOLER PRO 100

- Weight 50,8 kg
- Size 97,8 (W) x 51,4 (D) x 67,3 cm (H)
- 94,6 litre Cooler

Hunter Green **PA3340**

Black **PA3341**

Redwood **PA3342**

Caramel **PA3343**

Colours: Hunter Green, Black, Redwood & Caramel



PAR AIDE RANGE BALL STORAGE BOX

- Sturdy storage box holds up to 5.000 golf balls.
- Powder coated metal bottom allowing golf balls to vent and dry.
- Dual top opening for easy acces.
- Recycled plastic wood-slats are rustproof and fade resistant.
- Fully lockable.
- Size: 97,8 cm (W) x 70,8 cm (D) x 67,9 cm (H).

Range ball storage box, Hunter Green **PA3350**

Range ball storage box, Black **PA3351**

Range ball storage box, Redwood **PA3352**

Range ball storage box, Caramel **PA3353**



- CLOCKS -

CLOCK KIT

- Comes complete with outdoor clock and mounting kit.
- Pre-drilled holes in mounting bracket enables clock to be mounted to any Par Aide recycled plastic unit or on any other location of your choice.
- Size: Ø 39,5 cm.

Clock kit

PA3690



WALL CLOCK

- Stylish 'Station Type' double sided wall clock.
- Diameter: 40 cm.
- Aluminium housing.
- Radio controlled - always the exact time.
- Automatic change from summer to wintertime.
- Powered by 2x AA battery (penlite) – not included.
- Not waterproof, to be mounted in covered area only.

Wall Clock

MX38115



PATISSON TECHNOWOOD CLOCK / MESSAGE KIT

The new Technowood is a product similar to wood but does not present the limitations of the wood itself; it is made out of recycled PVC & Fiberglass and finished with a surface film giving a full 10 year warranty on colour retention and an estimated life of 30 years! No maintenance required at all and endless product possibilities.

The main advantages:

- Impact and pressure resistant.
- Resistant to water, humidity, heat and frost.
- UV resistant with a full 10 year colour retention guarantee.
- Absolutely maintenance free.
- Workability and fixing such as wood.
- Estimated lifetime of 30 years.



CLOCK / MESSAGE KIT

- Multipurpose message kit .
- Foldable for easy removal.
- Excluding clock.

Brown

P78610

Green

P78611

White

P78612

- ATOMIC CLOCK -



ATOMIC CLOCK 'INKA'

- Outdoor clock with galvanised steel case in 3-layer black lacquering finish.
- Clock face available with Roman or Arabic numerals.
- Highest standard clockwork movements warrant the perfect time all the time!
- Automatic time setting by aide of a radio transponder.
- Self-adjusting; clock automatically finds the right time zone and adjusts to summer- and wintertime.
- Shown on a stainless steel mounting frame with optional sponsor sign bracket.
- Wide variety of brackets and frames available.
- Height: 260 cm, Width: 81 cm.
- Complete with Lithium battery.
- As shown the frame will hold a 60 x 25 cm sponsor sign underneath the clock.

Clock 'Inka' **MX38111**
Stainless Steel Mounting frame **MX38112**



- INFORMATION SIGNS -



TEAK SERIE SIGNS

- Made of top quality teak wood.
- Teak harvested along the international regulations regarding conserving the forrest by replanting trees.
- Handmade to get that original traditional look.
- Size: (H) 57 x (W) 35 x (D) 5 cm.
- Standard with stainless steel spike.



TEAK SERIE SIGNS

CHIPPING GREEN	DU82306
PUTTING GREEN	DU82307
TEE 10 →	DU82308
← TEE 10	DU82309
← CARTS	DU82339
CARTS →	DU82391
G.U.R.	DU82315
NEXT TEE*	DU82337LR

*with → double sided, can be used both ways.

Customised **DU82334**
 Allow long lead time for customized teak signs.

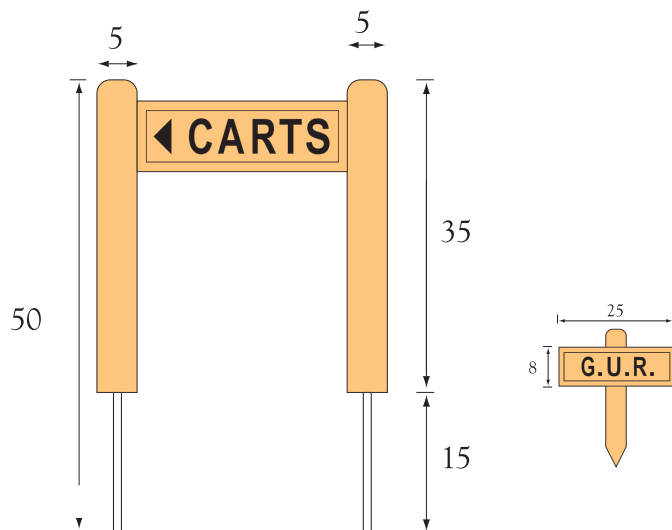

- INFORMATION SIGNS -



DURA-FLEX™ SIGNS

- 3-D molded-in letters means printing will not scratch off.
- U-shaped stainless steel spike, molded into the resin.
- Flexible and impervious to damage from balls and trolleys.
- Available in White, Green and Yellow.
- Size: 27 x 14 cm.

SIGNS:

- | | |
|---------------------------|---------------|
| White with Green letters | PA5610 |
| Green with White letters | PA5620 |
| Yellow with Black letters | PA5630 |



Unique U-shaped Spike(s)



CAPITONS AVAILABLE FOR DURA-FLEX SIGNS:

- | | | |
|------------------------------|---------------------------|-----------------|
| -01 Ground Under Repair | -09 Please Replace Divots | -18 Carts → |
| -02 Tee Area Closed | -10 Please Keep Off | -19 ← Next Tee |
| -03 No Carts Past Here | -11 Carts Scatter | -20 Next Tee → |
| -04 Keep Carts On Path | -12 Putting Green Closed | -22 Trolleys → |
| -05 Please Rake Bunkers | -13 No Chipping | -23 ← Trolleys |
| -06 Please Repair Ball Marks | -14 Next Tee ↑ | -24 No Trolleys |
| -07 Drop Area | -16 No Carts | -25 Drop Zone |
| -08 Wet Area Carts Keep Off | -17 ← Carts | |



WOOD DIRECTIONAL SIGNS

- Give your golf course a timeless, traditional look with our new hardwood sign.
- Letters are routed and painted.
- Each sign is individually hand oiled to maintain a rich, hard wood colour.
- Stainless steel spikes.
- Size: 27 x 14 x 2 cm.

Wood directional sign

PA5660



CAPITONS AVAILABLE FOR WOOD DIRECTIONAL SIGNS:

- | | | |
|------------------------------|--------------------------|-----------------|
| -01 Ground Under Repair | -07 Putting Green Closed | -14 No Chipping |
| -02 Tee Area Closed | -08 Please Keep Off | -15 Drop Zone |
| -03 Keep Carts On Path | -09 Carts → | -16 ← Carts |
| -04 No Carts Past Here | -10 Next Tee → | -17 ← Next Tee |
| -05 Please Repair Ball Marks | -12 No Carts | |
| -06 Drop Area | -13 Native Area No Carts | |

- INFORMATION SIGNS -



SIGN PATTISSON

- Staked sign.
- Colour: white.
- Please indicate required text for custom sign.

SIGN PATTISSON 30 X 20 CM

Pattison spiked sign 30 x 20 cm white **PCA707**
Please order sticker separatly.



STICKERS SIZE 30 X 20 CM, GREEN ON WHITE

Sticker Next Tee	PCA707/NT
Sticker Out of Bounds	PCA707/OB
Sticker Ground under repair	PCA707/GUR
Sticker Trolleys this way	PCA707/TTW
Sticker Please repair divots	PCA707/PRD
Sticker Please repair pitch marks	PCA707/PRP
Sticker Custom text	PCA707/C



GREEN LINE FAIRWAY SIGNS

- Single or double sided signage with 13 cm galvanized screw-in stakes.
- Choice of 2 sizes: 23 cm x 38 cm or 15 cm x 30 cm.
- Tough, long-lasting laminated material.
- Outstanding fade-resistance.



GREEN LINE FAIRWAY SIGNS SINGLE SIDED

	15 X 30 CM	23 X 38 CM
Carts on path only	SG09501	SG09901
Drop Area	SG09502	SG09902
Ground under repair	SG09503	SG09903
Keep carts 30' from green	SG09504	SG09904
No carts	SG09505	SG09905
Please repair ball marks	SG09506	SG09906
Replace divots	SG09507	SG09907
Customized sign	SG09598	SG09998

GREEN LINE FAIRWAY SIGNS DOUBLE SIDED

	15 X 30 CM	23 X 38 CM
Carts on path only	SG09551	SG09951
Drop Area	SG09552	SG09952
Ground under repair	SG09553	SG09953
Keep carts 30' from green	SG09554	SG09954
No carts	SG09555	SG09955
Please repair ball marks	SG09556	SG09956
Replace divots	SG09557	SG09957
Customized sign	SG09599	SG09999

- INFORMATION SIGNS -



FAIRWAY SIGNS & DIRECTION ARROWS

- Available in traditional classic green, tan and yellow.
- Cast aluminium signs with easy-to read decals on both sides.



Fairway sign green / tan
23 x 11 cm

FAIRWAY SIGN 23 X 11 CM	GREEN / WHITE
Carts On Path Only	SG09151
Drop Area	SG09152
Ground Under Repair	SG09153
No Carts	SG09155
Please Repair Ball Marks	SG09156
Replace Divots	SG09157
Plain Green	SG09158



Direction arrow green / white
28 x 6 cm

DIRECTION ARROWS GREEN / WHITE		
	28 X 6 CM	38 X 10 CM
Carts	SG10150	SG10050
Next Tee	SG10152	SG10052
Golf Cars	SG10154	SG10054
No. Tee		SG10056
Buggies	SG10160	SG10060
Trolleys	SG10162	SG10062
Plain Green	SG10158	SG10058



Direction arrow white / yellow
28 x 6 cm

DIRECTION ARROWS WHITE / YELLOW		
	28 X 6 CM	38 X 10 CM
Carts		SG10000
Next Tee	SG10102	SG10002
Golf Carts	SG10104	



LAMINATED DIRECTIONAL SIGNS

- These laminated signs are routed, wheater resistant, extremely durable and affordable.
- Available in yellow and green.
- Size: 25,4 x 14 cm.

CAPITONS AVAILABLE FOR LAMINATD DIRECTIONAL SIGNS:

	GREEN	YELLOW
Ground Under Repair	MT681100	MT681200
Tee Area Closed	MT681101	MT681201
Keep Carts On Path	MT681102	MT681202
Drop Area	MT681103	MT681203
Drop Zone	MT681104	MT681204
Putting Green Closed	MT681105	MT681205
Carts → (Double sided)	MT681106	MT681206
Next Tee → (Double sided)	MT681107	MT681207
No Carts	MT681109	MT681209
Native Area	MT681110	MT681210
Native Area No Carts	MT681111	MT681211
Please Repair Ball Marks	MT681112	MT681212
No Carts Past Here	MT681113	MT681213
No Chipping	MT681114	MT681214



- INFORMATION SIGNS -

STAINLESS STEEL MESSAGE HOLDER

- A classy and durable solution for any message you would like to put on the tee.
- Made of stainless steel.
- Can also be used as contest indicator.
- Holds 20 x 15 cm cards (not included).

Stainless steel message holder **PC19210**



Hinged lid provides easy access to message card.

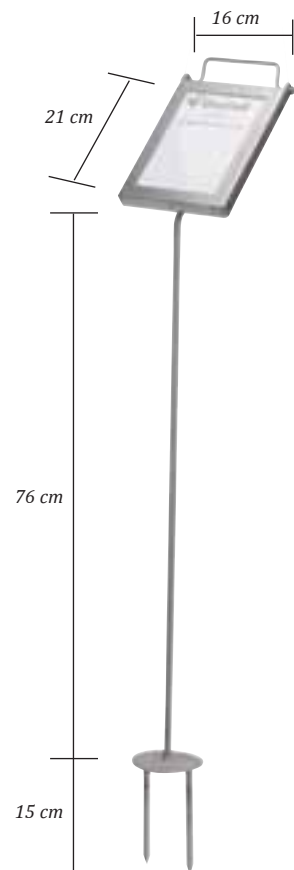

30 X 30 CM INFORMATION SIGN

- Single-sided aluminium sign.
- Silk-screened with weather-resistant ink.
- Size: 30 x 30 cm.

Aluminium sign white with dry erase marker **SG10330**
Order Sign post separately.



SIGN POST

- Available in two sizes: 46 and 102 cm.
- Square steel tubing finished in black powder coating.
- Fits any standard or custom 30 x 30 cm sign.

Sign post 46 cm **SG10418**
 Sign post 102 cm **SG10400**

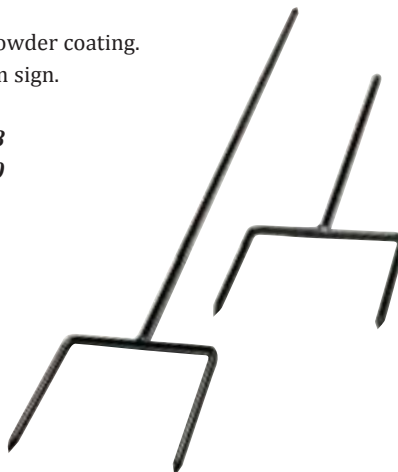

- RAKES -



PATISSON SCREW-FIT STANDARD RAKE

- Fibreglass 120 cm handle complete with factory fitted grip.
- Handle screw-fits into head.
- Colour: green.
- Head size: 58 cm.
- Packed: 10 per box.

Head only *P507505T*
Screw-fit handle *P507507G*

BUNKER RAKE HANDLE DECALS

Direct players to leave rakes in or out of bunkers.
Thirteen to a set; kiss-cut for easy use.

“Leave Rakes In Bunkers” *PA965-1*
“Leave Rakes Out of Bunkers” *PA965-2*



THE JOST BUNKER RAKE

- Light & flexible.
- Supplied with wooden handle, 170 cm.
- Head size: 63,5 cm.

Jost rake complete *DU36001*
Jost handle only *DU36021*
Jost head only *DU36002*

RAKE BEARER

- Yellow powder coat finish.
- Ideal for keeping your rake in place and your rake handle clean.
- Packed: 6 per box.

Bearer *DU36003*

- RAKES -



PATTISSON PRO RAKE

- Round edges on each end for a clean finish.
- High-density lightweight polyethylene head.
- Extra strong – guaranteed ‘no splinter’- composite handle.
- Two handle sizes and two head sizes.
- Heads can also be used in combination with the Gold Rake handle.
- Heads & handles packed per 25.

Pattissoon Pro complete 43 cm, 137 cm handle **P507650**
 Pattissoon Pro complete 43 cm, 183 cm handle **P507651**

Pattissoon Pro complete 63 cm, 137 cm handle **P507660**
 Pattissoon Pro complete 63 cm, 183 cm handle **P507661**

Pattissoon Pro rake head 43 cm **P507665**
 Pattissoon Pro rake head 63 cm **P507666**
 Pattissoon Pro green composite handle 137 cm **P507655**
 Pattissoon Pro green composite handle 183 cm **P507656**



PATTISSON TOUR RAKE

- Economical, ultralight rake - one-handed use.
- Lightweight, high-density polyethylene head.
- Quick screw-on assembly.
- Available with 120 cm aluminum handle or a yellow or green plastic coated steel handle.
- Packed per 12.

Pattissoon Tour rake with aluminum handle **P507611**
 Pattissoon Tour rake with yellow handle **P507600**
 Pattissoon Tour rake with green handle **P507610**

Pattissoon Tour rake head only **P507601**
 Pattissoon Tour rake aluminum handle only **P507616**
 Pattissoon Tour rake yellow handle only **P507605**
 Pattissoon Tour rake green handle only **P507615**



- RAKES -



GOLD RAKE

- Bend shape keeps handle from the ground.
- Aluminum handle.
- Head size: 58 cm.



Gold Rake complete
Gold Rake, head only
Gold Rake, handle only

DU36008
DU36011
DU36012



PATTISSON PRO RAKE

- Round edges on each end for a clean finish.
- High-density lightweight polyethylene head.



Pattison Pro rake, 43 cm, head only
Pattison Pro rake, 64 cm, head only
Gold Rake handle

P507665
P507666
DU36012

- RAKES -

All below rake heads fit the Gold Rake handle.



ACCUFORM ACE II

- Short-tooth tines with tapered sides for smooth finish in bunker.
- Patented round back with tapered sides.
- Made of impact resistant PE – superior Accuform Quality.
- Available in 43 cm and 64 cm width.

Accuform ace II head, 43 cm, head only	<i>PA990-01</i>
Accuform ace II head, 64 cm, head only	<i>PA995-01</i>
Gold Rake handle	<i>DU36012</i>
End Cap	<i>DU36017</i>



ACCUFORM ACCUCURVE

- Short-tooth tines with curved back.
- Patented 2-sided profile.
- Made of impact resistant PE – superior Accuform Quality.
- Head size: 31 cm.

Accuform Accucurve Head, 31cm, head only	<i>PA997-01</i>
Gold Rake handle	<i>DU36012</i>



TOURSMOOTH II

- Short-tooth's tines with curved back.
- Reinforced high- impact plastic head.
- Head size: 38 cm.

Tour smooth II, 38cm, head only	<i>SG11801</i>
Gold Rake handle	<i>DU36012</i>



- RAKES -



THE ACCUFORM® ACE II

The rake that started the revolution, the ultra-lightweight, patented Accuform® Ace.

- The first rake with short-tooths tines on one side for raking and a special surface for smoothing. It eliminates bad lies in the bunker.
- One-piece head, constructed of impact-resistant high-density polyethylene.
- Available in 43 cm width and the tour-popular 64 cm width.
- The most widely recognised bunker rake in the world.
- Preferred by top superintendents worldwide.

ACCUFORM® ACE II 43 CM

- Weight: 0,9 kg.



- | | |
|-------------------------------------|-----------------|
| With 137 cm green honeycomb handle | PA990-1 |
| With 137 cm green aluminium handle | PA990-5 |
| With 137 cm green ProTect handle | PA990-8 |
| With 137 cm sienna brown alu handle | PA990-10 |
| Head only | PA990-01 |

ACCUFORM® ACE II 64 CM

- Weight: 0,9 kg.



- | | |
|---|-----------------|
| With 137 cm green honeycomb handle | PA995-1 |
| With 137 cm green aluminium handle | PA995-5 |
| With extra long handle, 240 cm | PA995-7 |
| With 137 cm green ProTect handle | PA995-8 |
| With 183 cm green ProTect handle | PA995-9 |
| With 137 cm sienna brown aluminium handle | PA995-10 |
| Head only | PA995-01 |

Rake heads fits Gold Rake handle of page 162.

- RAKES -
STANDARD
GOLF COMPANY



TOUR PRO

When mediocrity isn't an option and only perfection will do, turn to the Tour Pro Bunker Rake. No other bunker rake can make smooth, level, playable surfaces like the Tour Pro.

- Made from a stronger and lighter-weight material.
- 51 cm and 63 cm heads ensure tracks are covered with minimum effort, while pioneering design generates tournament quality surfaces.
- When durability is a must, the Gator grip handle is the best option. Available in both 152 cm and 183 cm lengths.
- A single self-tapping screw (included) is all you need for assembly.
- Packed 12 per box only the curved handles are packed per 6.

51 CM TOUR PRO HEAD

With 163 cm green aluminum curved handle	SG11750
With 137 cm green composite handle	SG11700
With 137 cm green aluminum handle	SG11760
With 152 cm green Gator grip handle	SG11720
With 152 cm brown Gator grip handle	SG11730
Head 51 cm only	SG11701

63 CM TOUR PRO HEAD

With 152 cm green Gator grip handle	SG11790
With 183 cm green Gator grip handle	SG11770
With 183 cm brown Gator grip handle	SG11780
Head 63 cm only	SG11771

- RAKES -



Par Aide offers a full line of replacement handles and grips as well as decals with rake placement instructions.

- Honeycomb core offers greater strength.
- Hollow design is lighter.
- Improved UV protection for longer lasting.



FIBREGLASS HONEYCOMB HANDLE

- Fibreglass honeycomb handle offers greater strength.
- Fibreglass handles contain improved UV protection to maximize handle life.



PROTECT HANDLE

- ProTect handle features a thermoplastic coating to dramatically decrease the chance of fibreglass splinters.



POWDER COATED ALUMINIUM

- Powder coated aluminium for a non fibreglass option.
- Lightweight yet strong.
- Now available in brown or green.

BUNKER RAKE HANDLES AND GRIPS

HANDLES

- Green honeycomb fibreglass handle with rubber grip (137 cm)
- Green ProTect (thermoplastic coated) handle (137 cm)
- Green ProTect (thermoplastic coated) handle (183 cm)
- Green powder coated aluminium handle (137 cm)
- Brown powder coated aluminium handle (137 cm)

- PA972-1*
- PA972-8*
- PA972-9*
- PA972*
- PA972-10*

GRIPS

- Rubber grip, package of 10

- PA974-10*

- RAKES -



LOOK TO STANDARD GOLF FOR THE BEST RAKES IN THE BUSINESS

Whether you're looking for strength or affordability – or both, there's no reason to look any further. Our sand bunker rakes are specifically designed for golf course use. And there's a perfect rake for every need and budget!

TOUR-LITE™ RAKE

The Tour-Lite™ rake is designed with the same curvature and teeth as our popular Tour Smooth™ rake, but lighter in weight for easy, one-handed use. It rakes and smoothes in one, easy motion.

The ultralight handle and head are threaded for quick assembly. No screws and no cracked handles.

- High-density polyethylene head moulded from recycled materials.
- Ultralight plastic-coated steel handle.
- Handle grip cap.
- Weight: 0,53 kg.
- Size handle: 137 cm.
- Size head: 38 cm.
- Packed: 12 per carton.

- Complete rake with yellow ultralight handle
- Complete rake with green ultralight handle
- Tour-Lite™ head only
- Yellow ultralight steel handle only
- Green ultralight steel handle only

- SG12350**
- SG12375**
- SG12301**
- SG12305**
- SG12306**



ECONOMY RAKE

- Economical in price.
- Available with wooden handle.
- Bright yellow or green handle.
- Weight: 0,42 kg.
- Size wooden handle 122cm.
- Size head: 38 cm.
- Packed: 12 per carton.

- Complete rake with yellow wooden handle
- Complete rake with green wooden handle

- Economy rake head only
- Yellow wooden handle only
- Green wooden handle only

- SG11600**
- SG11625**
- SG11601**
- SG11605**
- SG11626**



- RAKES -



15" TOUR SMOOTH II RAKE

Time-tested design and performance of the Tour Smooth bunker rake just got an upgrade. Improved rake assembly and the addition of the exclusive Gator grip handle makes the Tour Smooth II complete.

- Smoothes both fine and course sand into perfect playing conditions quickly and easy.
- A single self-tapping screw (included) is all you need for assembly.
- Weight: 0,83 kg.
- Size handle: 137 cm.
- Size head: 38 cm.
- Packed: 12 per carton.

Complete rake with green aluminium handle	SG11860
Complete rake with green composite handle	SG11800
Complete rake with green Gator grip handle	SG11820
Complete rake with brown Gator grip handle	SG11830
Complete rake with green aluminium curved handle	SG11850

Tour Smooth II 15" head only	SG11801
Bolt assembly	SG11502
Natural aluminium handle only	SG11205
Yellow aluminium handle only	SG11515
Green aluminium handle only	SG11516
Tan composite handle only	SG11214
Green composite handle only	SG11216



Rake heads fits Gold Rake handle of page 162.

COMPOSITE HANDLES

Composite handles for the Tour Smooth® and Duo-Rake™ lines are stronger than fibreglass, resist fading in sunlight and totally end the nightmare of fibreglass splinters in players' hands. They'll hold up without breaking, fading, or splintering with normal use. Available in tan, yellow and green.

- BUNKER STAMP & RAKES -

BUNKER STAMP

- Impress your golfers by displaying a message or logo in the bunker.
- Rubber mould easily gets placed in the bunker and leaves a perfect image by only stepping on it.
- Can be used year after year.
- Price based on the size of the stamp.

Thanks for Raking (0,20 m2) **DU36100**
Bunker stamp Small (0,28 m2) **DU36101**
Bunker stamp Medium (0,55 m2) **DU36102**



BUNKER DEBRIS SIEVE

Want your bunkers to look better and play better? Quickly and easily clear rocks, leaves, twigs and other debris from bunkers using the Bunker Debris Sieve. Simply use it like a rake by dragging it through your bunkers.

- Sand sifts through the openings leaving debris trapped in the basket.
- Head size: 48 cm.
- Wooden 183 cm handle.



With 1,30 cm openings **SG29325**
With 0,64 cm openings **SG29350**

DEBRIS RAKE

- Great for removing pine needles and as a replacement for traditional bunker rakes.
- Gusseted heads adds extra strength for demanding locations such as waste areas.
- 23 cm head is perfect for maintaining shrubs, flower beds or any other tight areas.
- Mounts to 152 cm padded fibreglass handle for maximum strength, reach and comfort.
- Packed per 2 in a box.

Debris rake 53 cm **SG11300**

**STANDARD
GOLF COMPANY**



- SHOE CLEANERS -



SQUARE PATTERN BOOT WIPER

- All steel frame complete with scrapers.
- Four replaceable brushes.
- Ideal in any location.
- Wide stable base for easy use.
- Zinc-passivated prior to powder coating to provide excellent protection for many years of outdoor use.
- Side brushes to clean sides of shoes as well as base.
- Brushes can be easily cleaned or replaced.

P706907

Square pattern replacement brushes

Set of 4

P707908



DUCHELL SHOE BRUSH

- Green, powder coated heavy duty shoe brush.
- For superb cleaning of your golf shoes.
- Complete with wooden knob.

Duchell shoe brush	DU49413
Replacement bottom brush	DU49414
Replacement side brush, set of 2	DU49415
Replacement wooden knob	DU49417

- SHOE CLEANERS -



PORTABLE SPIKE BRUSH STAND

It offers the stability and cleaning effectiveness of a fixed-position brush stand, and yet you can move it to wherever it's needed.

- Patented design features base brushes and side brushes to thoroughly clean shoes.
- Holds steady on hard surfaces with integral rubber pads; spikes available to secure turf.
- Hunter Green and Medium Grey models available.
- Includes one set of message decals.
- Weight: 26,5 kg.

Brush stand, Hunter Green **PA512-11**
 Brush stand, Medium Grey **PA513-11**

Turf mounting spikes for brush stands **PA321-3**
 (set of 3)

Extra sets of usage decals (set of 3) **PA517**
 "Thank you for wearing alternative spikes"
 "Please clean spikes before entering"
 "Thank you for cleaning your shoes"



DELUXE SCRUSHER AND SCRUSHER

- Three separate bottom brushes now with softer, longer-lasting nylon bristles.
- Two side brushes with gentler bristles that don't scratch the sides of shoes.
- Cleans bottoms and side at the same time.
- The wider design of the Deluxe Scrusher offers more stability and extra space between lower bristles to prevent buildup.
- UV, environmentally safe, powder-coated finish included on the Deluxe model.
- Replaceable brushes.
- Optional equipment: 15 cm stakes for anchoring the Scrusher in asphalt, 46 cm stakes for anchoring the Scrusher in turf.

Scrusher **SG14100**
 Deluxe Scrusher **SG14000**

MOUNTING STAKES

Asphalt mounting stake, 15 cm **SG14106**
 Turf mounting stake, 46 cm **SG14124**

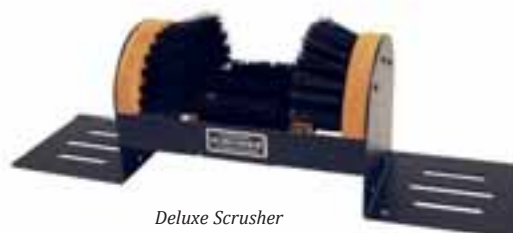

- SHOE CLEANERS -



FLOOR MOUNT COMBINATION

- Weight: 1,35 kg.

Alternative brushes *PA549-11*



SINGLE PIPE MOUNT SPIKE BRUSH

- Weight: 1,35 kg.

Alternative brushes *PA552-11*



DOUBLE MOUNT SPIKE BRUSH

- Weight: 2,25 kg.

Alternative brushes *PA553-11*



BASE BRUSH - fits all models

Alternative spikes *PA554-11*



SIDE BRUSH - fits 549, 512 & 513 models

Side brush *PA548*



PIPE MOUNT BLACK CLAMP

With hardware *PA552-3*

- SHOE CLEANERS -



TECHNOBROSS STAINLESS STEEL SHOE CLEANER

- All metal components made of stainless steel.
- Belt driven brush for smooth and quiet operation.
- Dual starter button for extra safety.
- Large dirt collection tray on sliders for easy emptying.
- Automatic overload switch off.
- Size: 58 (W) x 66 (L) x 100 (H) cm.
- Weight: 40 kg.

Technobross

DU49426



PATISSON GOLF SHOE VALET

- The quickest, cleanest and most effective way to remove mud, dirt and debris from your shoes and buggy wheels using compressed air.
- Casing powder coated to help resist corrosion.
- Large sliding tray for easy removal of dirt.
- Quiet and safe operation.
- Easily cleaned stainless steel construction.
- Two replaceable airguns.
- Size: 116 (W) x 106 (D) x 92 (H) cm.
- Weight: 187 kg.

Golf shoe valet

DU49419

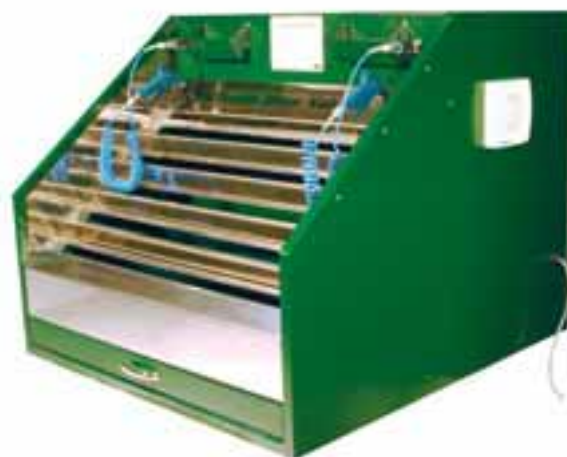

- CLEANING SYSTEM -



ZELUP CLEANING SYSTEM

The Zelup cleaning system is a patented 2 in 1 cleaning and drying system for clubs, shoes and trolleys.

When the double trigger gun is locked in its first position it acts like a traditional spray gun attachment; when fully locked it becomes a vaporizing spray that propels very fine water drops.

The unique defragmentation system uses only 0,25 to 1 litre of water per minute (which is up to 40 times less than traditional systems!) and allows perfect cleaning and drying with only one gun.

The kit comes with a connection box, hose and spray gun with brush and needs to connect to a small compressor (not included) & water supply.

The guns are supplied in 2 versions; the heavy duty (industrial version) in aluminium and the country club version in polycarbonate.

KIT ZELUP SPRAY INCLUDING CONNECTION BOX + HOSE + GUN + BRUSH - STICK AND BODY IN ALUMINIUM.

Zelup Kit with 2 metre hose	DU49432
Zelup Kit with 2,5 metre hose	DU49433
Zelup Kit with 3 metre hose	DU49434

KIT ZELUP SPRAY INCLUDING CONNECTION BOX + HOSE + GUN + BRUSH - STICK AND BODY IN POLYCARBONATE.

Zelup Kit with 2 metre hose	DU49436
Zelup Kit with 2,5 metre hose	DU49437
Zelup Kit with 3 metre hose	DU49438



ZELUP ACCESSORIES:

Z-Box, 100% Stainless steel construction - elegant solution.

Size: (L) 45 x (W) 45 x (H) 40 cm.

Z-Box (without Zelup Spray kit) - delivered flat packed

DU49439

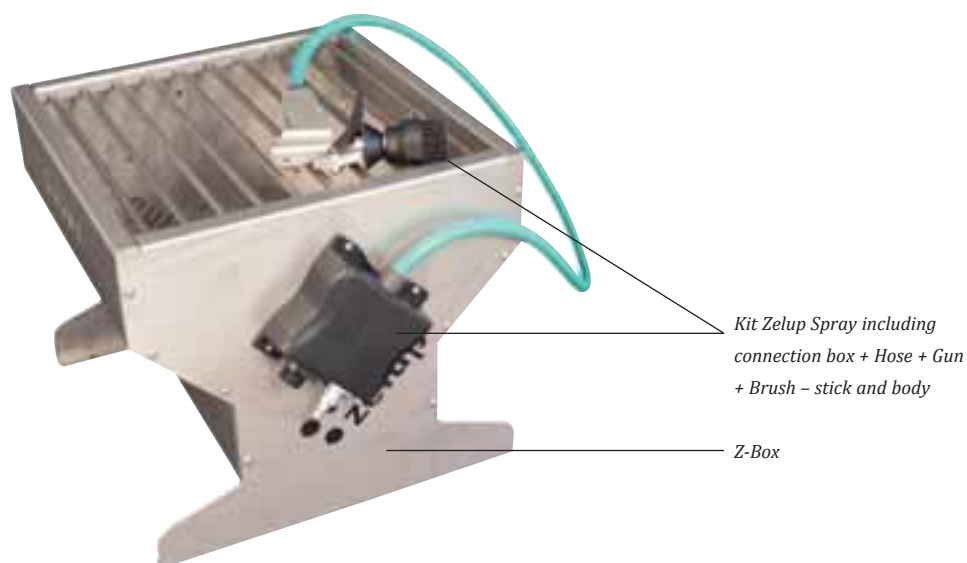

Z-STATION (NOT SHOWN)

1,5 x 1 metre galvanized frame with stainless adjustable feet

Z-Station prepared for Z-Box (Footprint for Z-Box)

DU49440

Z-Station not prepared for Z-Box (No Footprint for Z-Box - full grid)

DU49441

DISTRIBUTED BY:

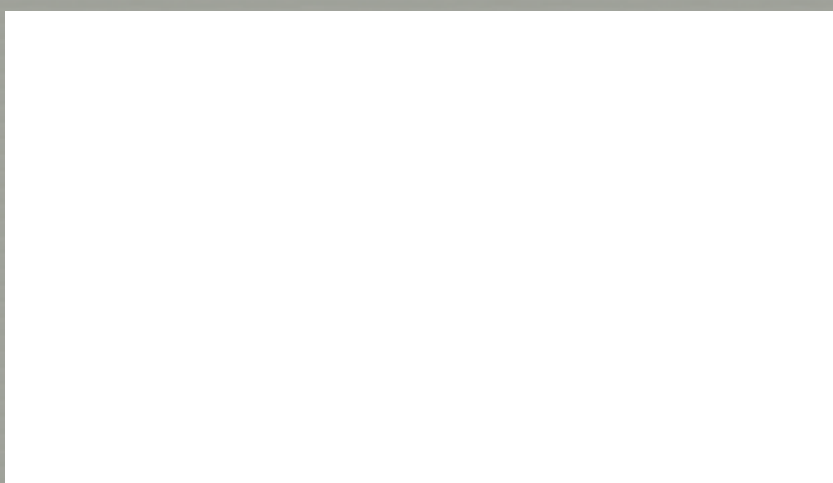

DUCHELL BV | STERREBERGWEG 40 | 3769 BT SOESTERBERG | THE NETHERLANDS
T +31(0)346 350 550 | **E** INFO@DUCHELL.COM

WWW.DUCHELL.COM